

# CODE OF PRACTICE FOR SAFE USE OF TOWER CRANES



This Code of Practice is prepared by the  
Occupational Safety and Health Branch  
Labour Department

---

First Edition            April 2002

Second Edition        October 2011

This Code of Practice is issued free of charge and can be obtained from the offices of the Occupational Safety and Health Branch of the Labour Department. It can also be downloaded from website of the Department at [http://www.labour.gov.hk/eng/public/content2\\_8b.htm](http://www.labour.gov.hk/eng/public/content2_8b.htm). For enquiries about addresses and telephone numbers of the offices, please refer to Labour Department's website at <http://www.labour.gov.hk/eng/tele/osh.htm> or call 2559 2297.

This Code of Practice may be freely reproduced except for advertising, endorsement or commercial purpose. Please acknowledge the source as "Code of Practice for Safe Use of Tower Cranes", published by the Labour Department.

---

**Code of Practice for  
Safe Use of Tower Cranes**

**October 2011 Edition**

**Corrigendum No. 1 (April 2012)**

**Page 82**

**Annex 2 – Procedures for Pre-delivery Checking of Tower Crane**

**Paragraph 4 (b)** replace the paragraph with the following:

- (b) unique identification of parts and components – unique identification to all main structural parts, motors, gearboxes, and braking systems of tower cranes to be used when referring to components in reports for inspection and testing, and certifications for repairs and modifications. Unique identification will not be required for pins and bolts used for connecting main structural parts if systems are in place for separating those that have passed non-destructive tests from the others. However, if the crane manufacturer specifies any limitations on the usage of the pins and bolts (such as with useful life based on the number of uses etc.), unique identifiers should be provided;

# CONTENTS

<b>Foreword</b> .....	<b>1</b>
<b>1. Scope</b> .....	<b>2</b>
<b>2. Definitions</b> .....	<b>3</b>
<b>3. Management of the Lifting Operation</b> .....	<b>6</b>
3.1 Safe system of work.....	6
3.2 Control of the lifting operation.....	6
<b>4. Planning of the Lifting Operation</b> .....	<b>7</b>
<b>5. Responsibilities/Requirements of Personnel</b> .....	<b>8</b>
5.1 Owner responsibilities.....	8
5.2 Tower crane operator .....	8
5.3 Slinger.....	9
5.4 Signaller.....	9
<b>6. Selection of Tower Cranes</b> .....	<b>11</b>
6.1 General .....	11
6.2 Types of tower cranes .....	11
6.3 Operational characteristics .....	19
<b>7. Markings and Documentation</b> .....	<b>21</b>
7.1 Identification .....	21
7.2 Safe working load charts.....	21
7.3 Instruction manuals and log book .....	21
<b>8. Operation Features of Tower Cranes</b> .....	<b>22</b>
8.1 Automatic safe load indicator .....	22
8.2 Brakes.....	22
8.3 Cabins for operators .....	22
8.4 Operating controls .....	23
8.5 Jib stops .....	23
8.6 Guards and protective structures .....	24
8.7 Electrical supply and equipment .....	24
8.8 Limiting switches.....	25

<b>9.</b>	<b>Siting of Tower Cranes.....</b>	<b>27</b>
9.1	General.....	27
9.2	Crane standing or supporting conditions .....	27
9.3	Proximity hazards.....	29
<b>10.</b>	<b>Erection, Dismantling and Height Alteration .....</b>	<b>34</b>
10.1	General precautions.....	34
10.2	Appointment of supervising engineer.....	36
10.3	Appointment of competent specialist contractor.....	37
10.4	Competent person for erection, dismantling or height alteration of tower crane.....	38
10.5	Competent workmen for the erection, dismantling or height alteration of tower crane .....	39
10.6	Manufacturer’s instruction .....	39
10.7	Pre-delivery checking .....	40
10.8	Provision of foundations, rail tracks and temporary roads .....	41
10.9	Installation of crane base of chassis and initial tower section .....	43
10.10	Erection of tower.....	44
10.11	Assembly and erection of counter jib.....	45
10.12	Counterbalance and ballast weights .....	45
10.13	Assembly and erection of main jib.....	46
10.14	Attachment of load-radius indicators and jib angle indicators .....	47
10.15	Check on completion of erection.....	47
10.16	Height alteration of a tower crane .....	48
10.17	Free-standing height and tying back.....	50
10.18	Dismantling.....	52
10.19	Use of derrick crane .....	53
<b>11.</b>	<b>Procedures and Precautions .....</b>	<b>54</b>
11.1	Leaving the crane unattended .....	54
11.2	Routine checks.....	56

11.3	Permit to work .....	58
11.4	Safe means of access.....	59
<b>12.</b>	<b>Safe Working Loads and Operating Conditions.....</b>	<b>60</b>
12.1	Safe working loads .....	60
12.2	Mode of operation and control .....	62
12.3	Handling of loads near persons .....	63
12.4	Carrying of persons by crane .....	63
12.5	Communication system.....	64
12.6	Weather conditions.....	64
12.7	Special conditions.....	65
<b>13.</b>	<b>Maintenance .....</b>	<b>66</b>
13.1	Statutory requirements .....	66
13.2	Planned maintenance .....	66
13.3	Competency of maintenance personnel .....	66
13.4	On-site repair/replacement work of an erected tower crane .....	67
<b>14.</b>	<b>Inspection, Examination and Testing .....</b>	<b>68</b>
<b>15.</b>	<b>Securing of Loads before Lifting .....</b>	<b>69</b>
15.1	Loads to be safely secured.....	69
15.2	Precautions to be taken before the lifting operation .....	69
15.3	Methods of slinging, their application and limitations .....	70
15.4	Precautions to be taken in fitting the slings.....	76
<b>Table 1 - Recommended hand signals .....</b>		<b>78</b>
<b>Table 2 - Frequency of test, thorough examination and inspection of tower cranes under the LALGR .....</b>		<b>79</b>
<b>Annex 1 - Risk Assessment for Erection, Dismantling and Height Alteration Operations of Tower Crane.....</b>		<b>80</b>
<b>Annex 2 - Procedures for Pre-delivery Checking of Tower Crane.....</b>		<b>82</b>
<b>Annex 3 - Procedures for Pre-delivery Checking of Derrick Crane .....</b>		<b>85</b>
<b>Annex 4 - Monthly Inspection and Maintenance of Tower Crane .....</b>		<b>87</b>
<b>Abbreviations .....</b>		<b>89</b>
<b>References .....</b>		<b>90</b>



## Foreword

Tower cranes are widely used for lifting operations in the construction industry in Hong Kong. Statistics show that tower cranes contribute to quite a number of serious accidents. Property damage and bodily injuries can be avoided if they are properly used.

This Code of Practice (hereafter referred as this Code) is approved and issued by the Commissioner for Labour under section 7A of the Factories and Industrial Undertakings Ordinance (Cap. 59) (hereafter referred as the FIUO). It provides practical guidance to the industry as to how to use tower cranes safely and properly with a view to assisting the duty holders in preventing accidents.

The provisions in this Code should not be regarded as exhausting those matters which need to be covered by the relevant safety legislation, nor is it intended to relieve persons undertaking the work of their statutory responsibilities. It is important to note that compliance with this Code does not of itself confer immunity from legal obligations.

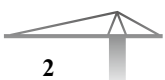
This Code has a special legal status. Although failure to observe any guidance contained in this Code is not in itself an offence, that failure may be taken by a court in criminal proceedings as a relevant factor in determining whether or not a person has breached any of the provisions of the regulations to which the guidance relates.

Throughout this Code, we have quoted relevant safety standards of the British Standards Institution. However, if there are other national/international standards or provisions which are equivalent, they would be acceptable as alternatives. In addition, statutory provisions referred to or cited in this Code are those in force as at 1 August 2011.



## 1. Scope

- 1.1 This Code provides guidance on the safe use and operation of tower cranes to ensure the safety of personnel working at or nearby those cranes.
- 1.2 This Code covers management and planning of the lifting operation of tower cranes, requirements for operators, slingers and signallers, siting, erection, dismantling, height alteration, maintenance and testing of tower cranes. It also contains guidance pertaining to the selection, safe use and specific precautions when tower cranes are operating within a workplace.
- 1.3 Reference is also made to relevant Hong Kong legislation in particular section 6A and 6B of the FIUO, the provisions in the Factories and Industrial Undertakings Regulations (Cap. 59A) (hereafter referred as the FIUR), the Factories and Industrial Undertakings (Lifting Appliances and Lifting Gear) Regulations (Cap. 59J) (hereafter referred as the LALGR), the Factories and Industrial Undertakings (Guarding and Operation of Machinery) Regulations (Cap. 59Q) (hereafter referred as the GOMR) and the Construction Sites (Safety) Regulations (Cap. 59I) (hereafter referred as the CSSR). Attention is drawn to the requirements and procedures for testing and examination of cranes under the LALGR and the British Standard BS 7121.



## 2. Definitions

### **Automatic safe load indicator**

It means a device intended to be fitted to a crane that automatically gives an audible and visible warning to the operator thereof that the crane is approaching its safe working load, and that automatically gives a further audible and visible warning when the crane has exceeded its safe working load (Regulation 3(1) of the LALGR).

### **Certified plan**

It includes drawings, details, diagrams, calculations, structural details, structural calculations, geotechnical details and geotechnical calculations which are certified by safety supervision personnel.

### **Competent examiner**

A competent examiner, in relation to the carrying out of any test and examination required by the LALGR, means a person who is -

- (a) appointed by the owner required by those regulations to ensure that the test and examination is carried out;
- (b) a registered professional engineer registered under the Engineers Registration Ordinance (Cap. 409) within a relevant discipline specified by the Commissioner for Labour; and
- (c) by reason of his qualifications, training and experience, competent to carry out the test and examination (Regulation 3(1) of the LALGR).

As at the date of this Code, Mechanical Engineering and Marine & Naval Architecture are the specified disciplines specified by the Commissioner for Labour.

### **Competent person**

A competent person, in relation to any duty required to be performed by him under the LALGR, means a person who is -

- (a) appointed by the owner required by those regulations to ensure that the duty is carried out by a competent person; and
- (b) by reason of training and practical experience, competent to perform the duty (Regulation 3(1) of the LALGR).

### **Climbing frames**

Frames of a climbing crane, which transfer the loadings from the crane on to the structure that supports it.

### **Climbing ladders**

Vertical structural frameworks by means of which some types of climbing cranes are raised.

### **Condition of tipping**

A condition when a crane is subject to an overturning moment which cannot be increased by even a small amount without causing the crane to fall over.

### **Free-standing height**

The maximum height at which a tower crane can operate without being held by ties or guys.

### **Gauge**

The dimension between the inner faces of the rail heads of the rail track of a crane.

### **Height alteration**

It means climbing of a tower crane or the addition or removal of mast section to or from the main tower.

### **Overlapping zone**

An overlapping zone is the space which may be swept by the load, its attachment or any part of the tower crane, and common to at least two tower cranes.

### **Owner**

In relation to any crane, includes the lessee or hirer thereof, and any overseer, foreman, agent or person in charge or having the control or management of the crane, and the contractor who has control over the way any construction work which involves the use of the crane is carried out and, in the case of a crane situated on or used in connection with work on a construction site, also includes the contractor responsible for the construction site (Regulation 3(1) of the LALGR). A contractor is responsible for a construction site if he is undertaking construction work there or, where there is more than one contractor undertaking construction work at the site, if he is the principal contractor undertaking construction work there (Regulation 3(2) of the LALGR).

### **Project engineer**

Project engineer means the registered structural engineer (RSE) appointed under section 4 of the Buildings Ordinance (Cap. 123) (hereafter referred to as BO); or for project(s) with exemption granted by the Building Authority from the procedures and requirements relating to the appointment of a RSE under section 4 of the BO, a competent person whose appointment is, subject to prior agreement of the Building Authority, to take up the responsibilities and duties of a registered structural engineer; or the supervising officer of similar capacity in project(s) of the Housing Authority; or the engineer(s) as specified in the works contracts appointed to act on behalf of the client organization for the supervision and management of the works project(s) of the government departments of the Hong Kong Special Administrative Region; or any independent checking engineer(s) of similar capacity appointed by the principal contractor at the request of the government departments of the Hong Kong Special Administrative Region, as the case may be.



**Rail ties**

Ties used to retain rails at the correct distance apart and to withstand the imposed tensile and compressive forces.

**Registered professional engineer**

Registered professional engineer means a person whose name is on the register of registered professional engineers established and maintained under section 7 of the Engineers Registration Ordinance (Cap 409).

**Registered safety officer**

Registered safety officer means a person registered under Regulation 7 of the Factories and Industrial Undertakings (Safety Officers and Safety Supervisors) Regulations (Cap 59Z).

**Registered structural engineer**

Registered structural engineer means a person whose name is for the time being on the structural engineers' register kept under section 3(3) of the BO.

**Safety supervision personnel**

For building works and street works, it means the “Technically Competent Person of Grade T5” (TCP T5) who possesses the academic or professional qualifications and experience of building works or street works that satisfy the requirements set out in the Code of Practice for Site Supervision issued by the Buildings Department for a particular type of site supervision or management tasks; or the person responsible for engineering safety supervision as specified in the works project(s) of the government departments of the Hong Kong Special Administrative Region, as the case may be. For other industrial undertakings, it means a registered professional engineer in structural discipline.

**Wedges**

The means of securing the tower within tie frames or climbing frames of a tower crane.

**Working space limiter**

A working space limiter is a limiting device to prevent the load, its attachment or any part of the tower crane from entering an overlapping zone.

### 3. Management of the Lifting Operation

#### 3.1 Safe system of work

3.1.1 A safe system of work should be established and documented by the owner. Such system should be followed for every lifting operation whether it is an individual lift or a series of repetitive operations. This safe system of work should be prepared and endorsed by the owner, with the advice of the competent person, safety officer and other relevant personnel. The same principle should be applied whether the lifting operations are carried out at a construction site or the crane is a permanent fixture, e.g. in a factory or at a dock. The safe system of work should be effectively communicated to all parties concerned by the owner.

3.1.2 The safe system of work should include but not limited to the following:

- (a) planning of the operation;
- (b) selection, provision and use of a suitable crane and equipment;
- (c) maintenance, examination and testing of the crane and equipment;
- (d) the provision of a log-book for the competent examiner/competent person/mechanic to enter the details of testing, examination, inspection, maintenance/repair works which have been carried out for the crane;
- (e) the provision of properly trained and competent personnel who have been made aware of their relevant responsibilities under sections 6A and 6B of the FIUO;
- (f) adequate supervision by properly trained and competent personnel;
- (g) observing for any unsafe conditions such as adverse weather conditions that may arise during operation;
- (h) ensuring that all necessary test and examination certificates and other documents are available;
- (i) preventing unauthorized movement or use of a crane at all times;
- (j) the safety of other persons who may be affected by the lifting operation; and
- (k) the contingency plan providing procedures to be followed in case of emergency situation.

3.1.3 The lifting operation should be taken to include any necessary preparation of a site, and the siting.

#### 3.2 Control of the lifting operation

3.2.1 To ensure the implementation of the safe system of work, a responsible person should be appointed to have overall control of the lifting operation. This appointed person should have adequate training and experience to enable these duties to be carried out competently.



## 4. Planning of the Lifting Operation

- 4.1 All lifting operations should be planned to ensure that they are carried out safely and that all foreseeable risks have been taken into account. Planning should be carried out by a competent person appointed for this purpose. In cases of repetitive or routine operations, this planning may only be necessary in the first instance, with periodic reviews to ensure that no factors have changed.
- 4.2 Planning should include the consideration of:
- (a) the load such as its characteristics and the method of lifting;
  - (b) the selection of a suitable crane appropriate to the operation, ensuring that adequate clearances are maintained between the load and the crane structure;
  - (c) the selection of lifting gear, the weight of which should be taken into account when assessing the load on the crane;
  - (d) the position of the crane and the load before, during and after the operation;
  - (e) the site of the operation, taking into account proximity hazards, space availability and suitability of the ground or foundation such as the allowable bearing capacity of the ground;
  - (f) any necessary erection, alteration and dismantling of the crane;
  - (g) the environmental conditions that exist or may occur at the site of the operation, which may necessitate stopping the operation when conditions are unsuitable; and
  - (h) the effectiveness of communication among relevant parties, such as that between the operator and the signaller(s).
- 4.3 **Risk assessment**
- (a) The risk assessment carried out by a competent person as part of the planning process should identify the hazards associated with the proposed lifting operation. The assessment should evaluate the risks involved and the nature and extent of any measures required to mitigate those risks. The competent person should also take into consideration hazards identified by the overall workplace risk assessments.
  - (b) Generic risk assessments are unlikely to be sufficient since most workplaces have hazards that are unique to that situation and should be taken into account in the separate workplace specific assessment. The results of the risk assessment should be used in the preparation of the method statement for the workplace.
  - (c) The risk assessment together with the manufacturer's instructions should then be used to develop a detailed method statement for the lifting operation in the workplace.

## 5. Responsibilities/Requirements of Personnel

### 5.1 Owner responsibilities

- 5.1.1 It is the responsibility of owner to ensure that the personnel who prepare the equipment, erect/alter/dismantle it, operate it, and work with it are well trained in both safety and operating procedures.
- 5.1.2 The owner must ensure erection, dismantling and height alteration operations of every tower crane are carried out by competent workmen under supervision of a competent person and monitoring by a supervising engineer as described in section 10 below.
- 5.1.3 The owner must ensure that all tower cranes are operated by trained, experienced, competent and qualified crane operators.
- 5.1.4 The owner and personnel working with a tower crane must also ensure that the personnel who direct, rig and handle the loads have received training in the principles of the operation, are able to establish weights and judge distances, heights and clearances, are capable of selecting tackle and lifting gear as well as rigging method suitable for the loads to be lifted, and are capable of directing the movement of the crane and load to ensure the safety of all personnel.
- 5.1.5 The owner is responsible for conducting risk assessment for all operations of a tower crane and putting together a crane safety programme and method statements, educating all related personnel in safe practices and the assignment of definite, individual safety responsibilities. The owner must plan all phases of the operations involving the crane.
- 5.1.6 The owner must ensure maintenance of every tower crane is carried out by inspection and maintenance technicians as described in section 13 below.
- 5.1.7 The owner must ensure all inspections, examinations and tests for the operations of every tower crane described in section 14 below have been carried out accordingly.

### 5.2 Tower crane operator

- 5.2.1 The tower crane operator should be responsible for the correct operation of the crane in accordance with the manufacturer's instructions and within the safe system of work. He should at any one time only respond to the signals from one slinger/signaller who should be clearly identified. In particular, the tower crane operator should:
- (a) have attained the age of 18 years and hold a valid certificate issued by either

the Construction Industry Training Authority before 1 January 2008 or the Construction Industry Council or by any other person specified by the Commissioner for Labour (Regulation 15A(1) of the LALGR);

- (b) have been adequately trained in the operation of the type of crane he is operating and have sufficient knowledge of the crane and its safety devices;
- (c) fully understand the duties of the slinger and be familiar with the signal code shown in Table 1 in order to implement safely the instructions of the slinger or signaller; and
- (d) fully understand the radio/tele-communication signals between the parties concerned.

### **5.3 Slinger**

5.3.1 The slinger should be responsible for attaching and detaching the load to and from the crane, and for the use of correct lifting gear in accordance with the planning of the operation. In particular, the slinger should:

- (a) have attained the age of 18 years;
- (b) be fit with particular regard to eyesight, hearing and reflexes;
- (c) be agile and have the physique to enable him to handle lifting tackle;
- (d) have been trained in the general principles of slinging and be able to establish weights and judge distances, heights and clearances;
- (e) be capable of selecting tackle and lifting gear as well as rigging method suitable for the loads to be lifted;
- (f) understand the signal code shown in Table 1 and be able to give clear and precise signals;
- (g) be capable of directing the movement of the crane and load in such a manner as to ensure the safety of personnel and plant; and
- (h) fully understand the radio/tele-communication signals between the parties concerned.

### **5.4 Signaller**

5.4.1 Where the crane operator of the tower crane does not have a clear and unrestricted view of the load carried by the crane or the point of attachment for a load where no load is being carried and such view is necessary for the safe working of the crane, a signaller shall be employed to relay the slinger's instructions to the crane operator (Regulation 15B(1) of the LALGR).

5.4.2 The signaller should be responsible for relaying the signal from the slinger to the crane operator. He is also responsible for directing the safe movement of the crane. In particular, he should:

- (a) have attained the age of 18 years (Regulation 15B(2) of the LALGR);



- (b) be fit with particular regard to eyesight, hearing and reflexes;
- (c) understand the signal code shown in Table 1 and be able to transmit the instructions of the slinger in a clear and precise manner; and
- (d) be easily identifiable to the crane operator (e.g. by wearing ‘high-visibility’ clothing, or other means).

## 6. Selection of Tower Cranes

### 6.1 General

- 6.1.1 Each class of cranes possesses certain basic characteristics which will usually dictate the one most suited to a particular application. Tower cranes must be selected to suit the job. If the crane's basic characteristics do not match the job's requirements, unsafe conditions will be created and accidents are prone to happen.
- 6.1.2 Reference should therefore be made to the following sub-sections 6.2 and 6.3 below for details of different crane types and their operational characteristics.
- 6.1.3 The type of tower cranes to be used should be considered against the job requirements for a particular application. Points to be considered in making the selection include:
- (a) weights and dimensions of loads;
  - (b) heights of lift and distances/areas of movement of loads;
  - (c) number and frequency of lifts;
  - (d) length of time for which the crane will be required;
  - (e) workplace conditions, including ground conditions for crane standing, and space available for crane access, erection, operation and dismantling; and
  - (f) any special operational requirements or limitations imposed including the existence of other cranes in close proximity.

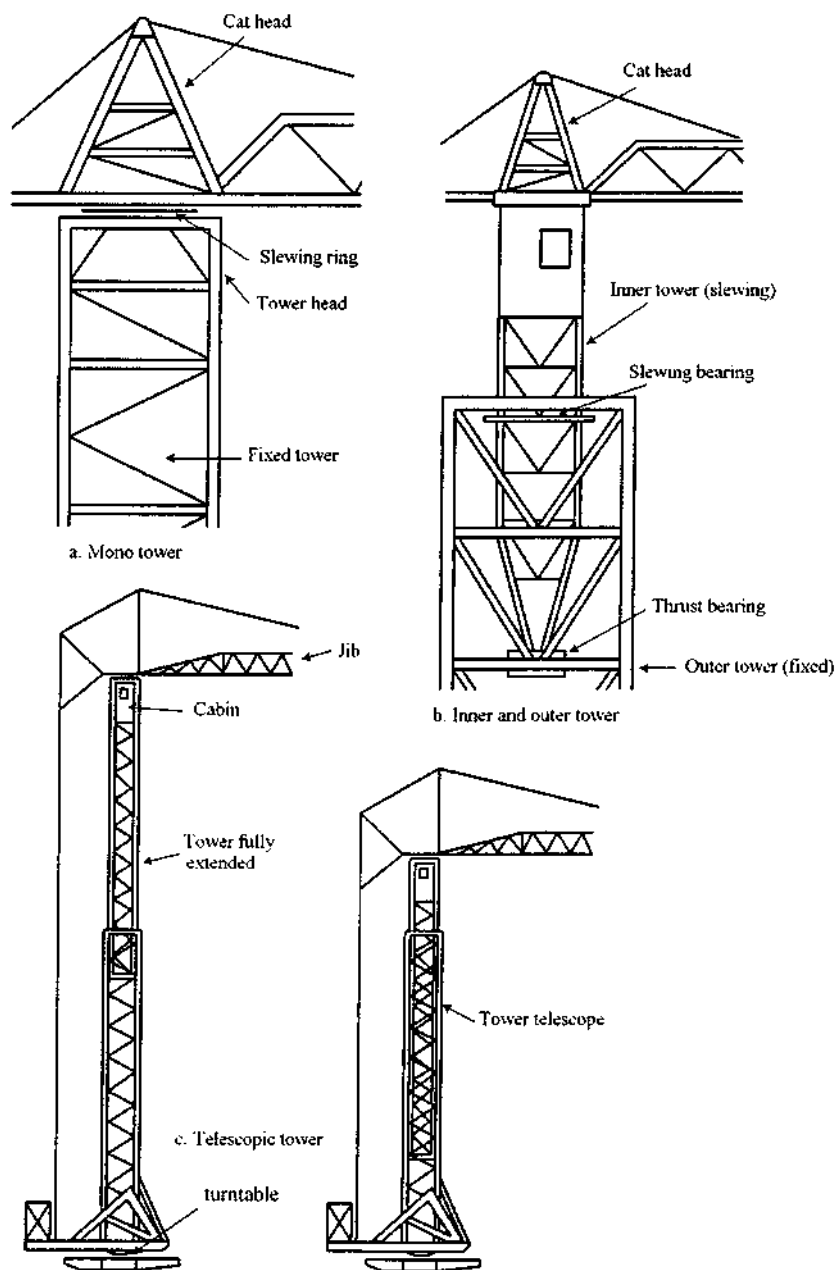
### 6.2 Types of tower cranes

- 6.2.1 Static and mobile tower cranes are available in a wide variety of types and configurations according to the particular combination of tower, jib and type of base which they employ.
- 6.2.2 Tower configurations (see Fig. 1)

Tower cranes are available with either fixed or slewing towers. On the fixed tower type the slewing ring is situated at or near the top of the tower and the jib slews about the vertical axle of the stationary tower. The slewing ring on the slewing tower type is situated at the bottom of the tower and the whole of the tower and jib assembly slew relative to the base of the crane. The towers can be further classified as being mono towers, inner and outer towers and telescopic towers.

- (a) *Mono Towers* - The jib is carried by a single tower structure which may be either fixed or slewing. Provision may be made in the design to permit the tower to be extended (see also Fig. 1a).

- (b) *Inner and Outer Towers* - They are characterised by the jib being carried by a fixed or slewing inner tower which is supported at the top of the fixed outer tower. Provision may be made in the design to permit the outer tower to be extended (see also Fig. 1b).
- (c) *Telescopic Towers* - The tower structure consists of two or more main sections which nest into each other to enable the height of the crane to be altered without the need for partial dismantling and re-erection. Telescopic towers are usually of slewing type and more common on rail-mounted and mobile tower cranes (see also Fig. 1c).

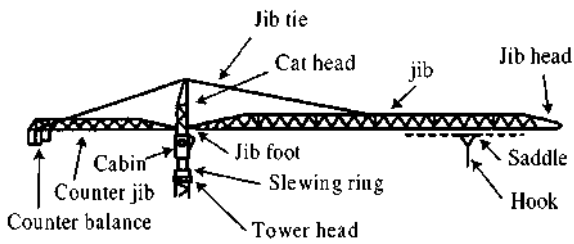


**Fig. 1 Types of tower on tower cranes**

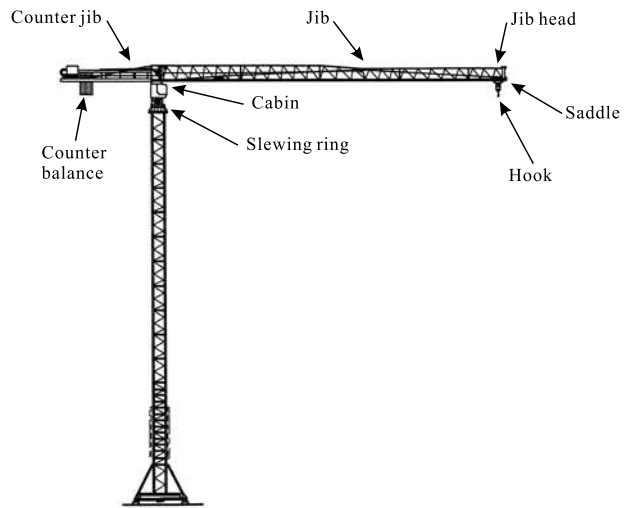
### 6.2.3 Jib configurations (see Fig. 2)

The main types of jib used on tower cranes are horizontal trolley jibs, luffing jibs, fixed-radius jibs, rear-pivoted luffing jibs and articulated jibs.

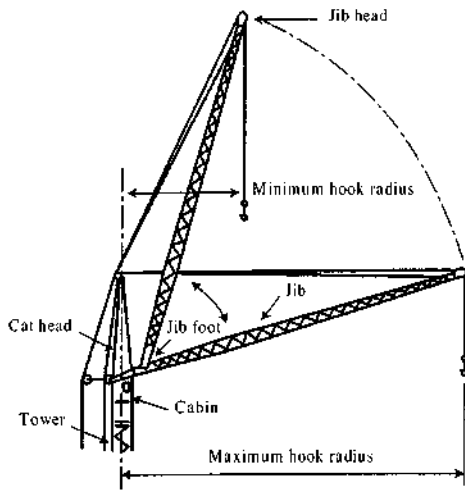
- (a) *Horizontal trolley jibs (“A” frame type)* - They are held in a horizontal or slightly raised position by tie bars or ropes connected to an “A” frame on the top of the tower crane. The hook is suspended from a trolley which moves along the jib to alter the hook radius. A suitable allowance needs to be made for deflection when calculating the clearance between adjacent cranes (see also Fig. 2a).
- (b) *Horizontal trolley jibs (flat top type)* – They are connected directly to the tower top and do not require tie bars or ropes connected to an “A” frame. This reduces the overall height of the crane. The hook is suspended from a trolley which moves along the jib to alter the working radius. A suitable allowance needs to be made for deflection when calculating the clearance between adjacent cranes (see also Fig. 2b).
- (c) *Luffing jibs* - They are pivoted at the jib foot and are supported by luffing cables. The hoist rope which supports the load usually passes over a sheave at the jib head, and the hook radius is altered by changing the angle of inclination of the jib (see also Fig. 2c).
- (d) *Fixed-luff jibs* - They are also mounted on pivots at the jib foot. Unlike the luffing jibs, these are held by jib-ties at a fixed angle of inclination. On some types, the hook is suspended from the jib head and the hook radius cannot be altered, whereas on others the hook is suspended from a saddle or trolley which travels on the jib (see also Fig. 2d).
- (e) *Rear-pivoted luffing jibs* - The jib pivot of this type of jib is situated at the top and behind the centre line of the tower and the hook is supported by the hoist rope which passes over a sheave at the jib head (see also Fig. 2e).
- (f) *Articulated jibs* - The jib has a pivot point somewhere in its middle area. Some models are level-luffing; that is, the hook elevation remains constant as radius changes. It is possible to provide either a trolley or a fixed-location hook or even a concrete pump-discharge line. Articulated jibs are mounted on towers identical to those used with horizontal trolley jibs (see also Fig. 2f).



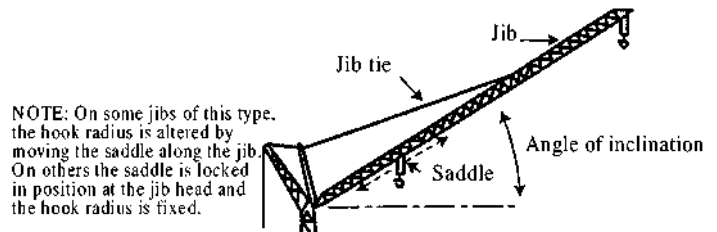
a. A-frame jib



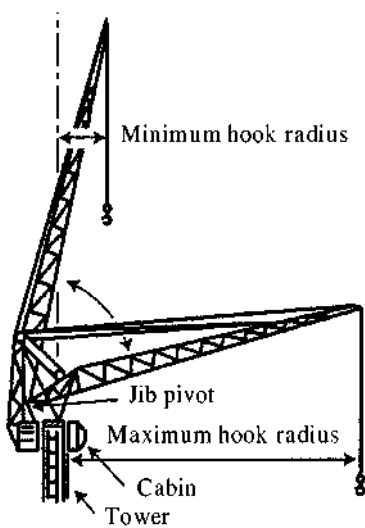
b. Flat top jib



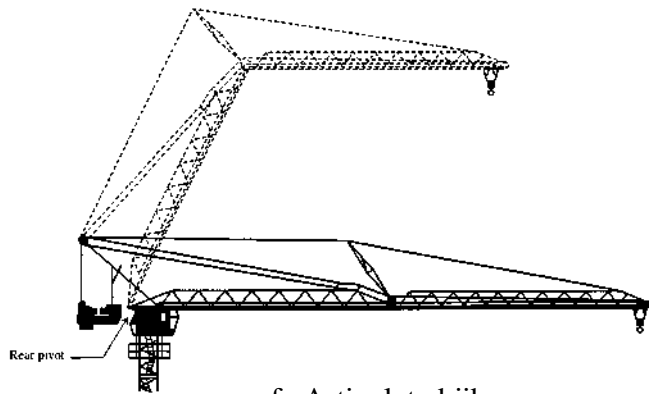
c. Luffing jib



d. Fixed luffing jib



e. Rear pivoted luffing jib



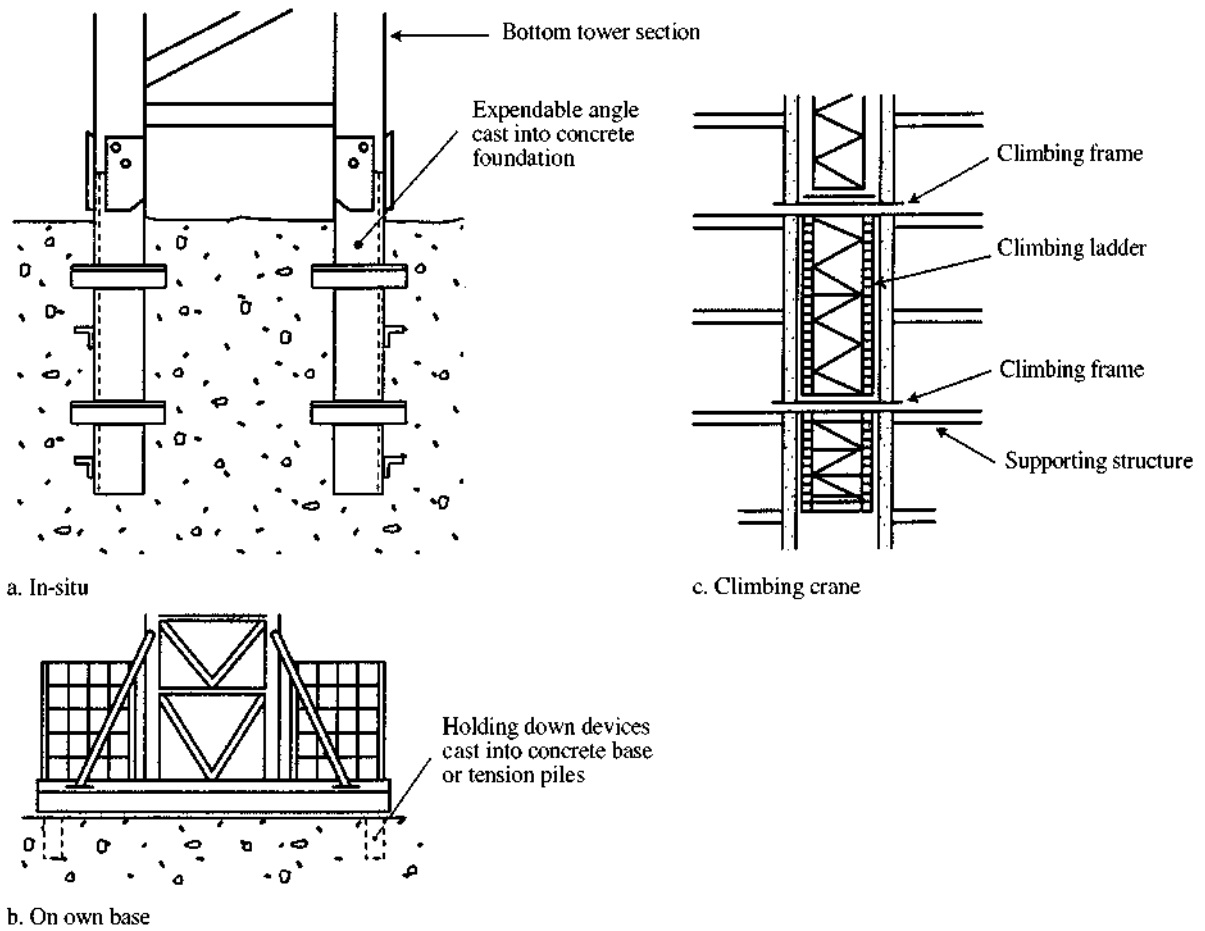
f. Articulated jib

Fig. 2 Types of jib on tower cranes

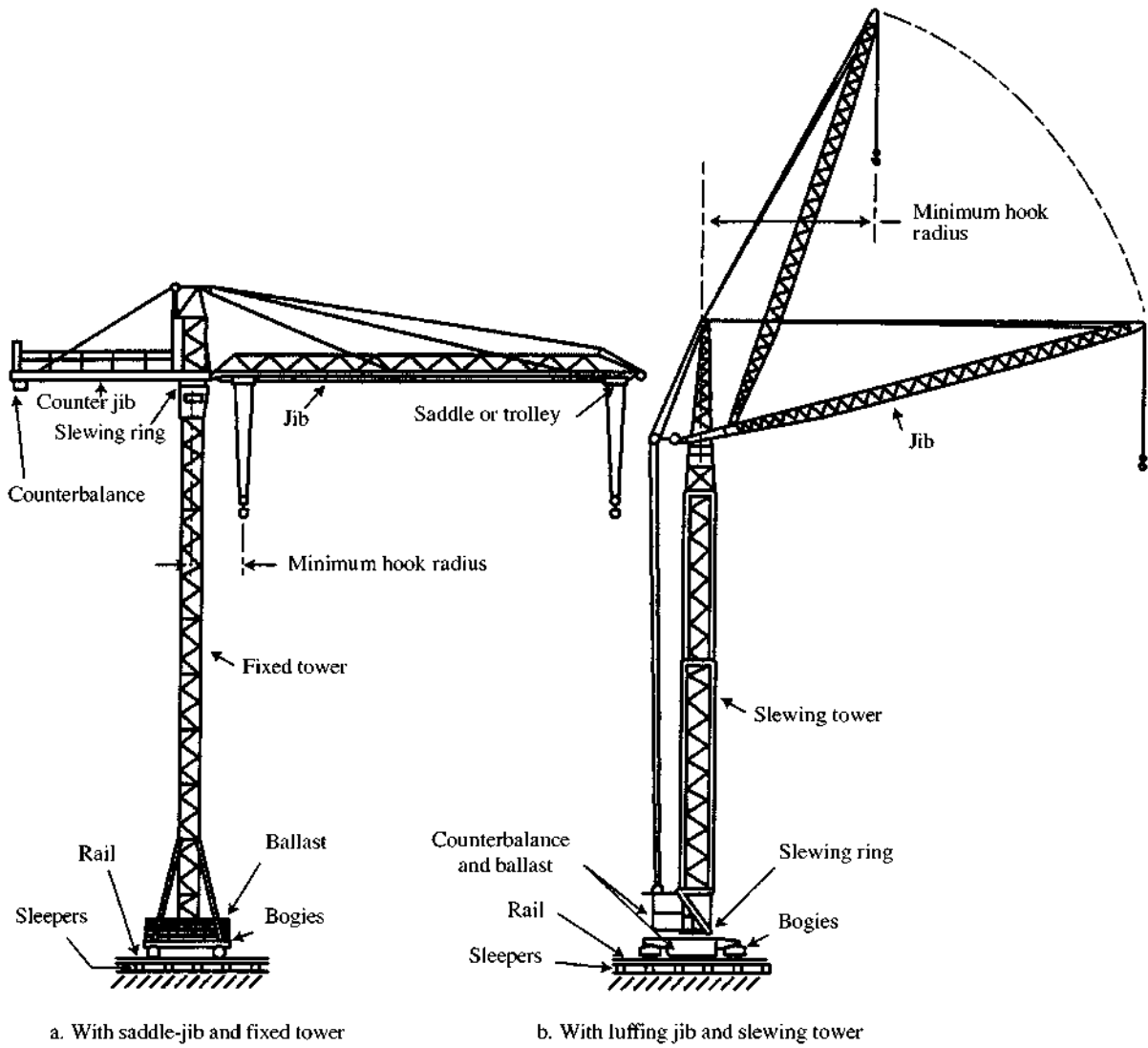
#### 6.2.4 Mounting configurations

Tower cranes are also characterised according to their mounting configuration. They are available as static bases, rail-mounted units and mobile units.

- (a) *Static bases* (see Fig. 3) - There are three main types of static bases.
  - (i) *In-situ base* - The crane is mounted on special corner angles, frames or an expendable tower section, cast into the concrete foundation block.
  - (ii) *On own base* - The crane is mounted on its own base section or chassis which, without wheels and travelling gear, but with ballast, stands on a concrete base.
  - (iii) *Climbing base* - The crane is supported by the structure which it is being used to construct, and to which it is attached by climbing frames and wedges. The height of the cranes can be extended as the height of the structure increases by means of climbing supports attached to the frames. Climbing support can be metal ladders, rods or tubes. A climbing crane may be mounted initially on a fixed base and its support be later transferred to climbing frames and supports.
- (b) *Rail-mounted units* - The cranes are mounted on a chassis frame which is supported on rail wheels. The wheels are usually double flanged. When all wheels are removed, some tower cranes can be used as static-based cranes (see Fig. 4).
- (c) *Mobile units* - The mobile mounting configuration consists of truck-mounted, wheel-mounted or crawler-mounted units.
  - (i) *Truck-mounted tower cranes* (see Fig. 5) - Tower cranes mounted on truck or lorry chassis are available. It is essential that this type of crane has its outriggers extended. The outriggers should be securely set up and level on its jacks when handling loads.
  - (ii) *Wheel-mounted tower cranes* (see Fig. 6) - These are not normally self-propelling and may be moved by towing by a suitable vehicle. They are provided with stabilizers or outriggers and jacks which should be set (and the wheels either removed or raised clear of the supporting surfaces) before commencing erection or lifting operations.
  - (iii) *Crawler-mounted tower cranes* (see Fig. 7) - There are two principal types of crawler bases used on this type of tower cranes. One is a twin-track type which is mounted on one pair of crawler tracks. The crane requires outriggers to be extended and jacks set when handling loads. The other is the straddle-type which is mounted on four widely spaced crawler tracks, each of which can be adjusted to height. Both types of tower cranes should be set firm and level when handling their rated safe working loads. In general, they do not have the same freedom of mobility as for example crawler-mounted mobile cranes. Reference should be made to the crane specification and to the manufacturer regarding conditions under which these machines may travel in their erected state.

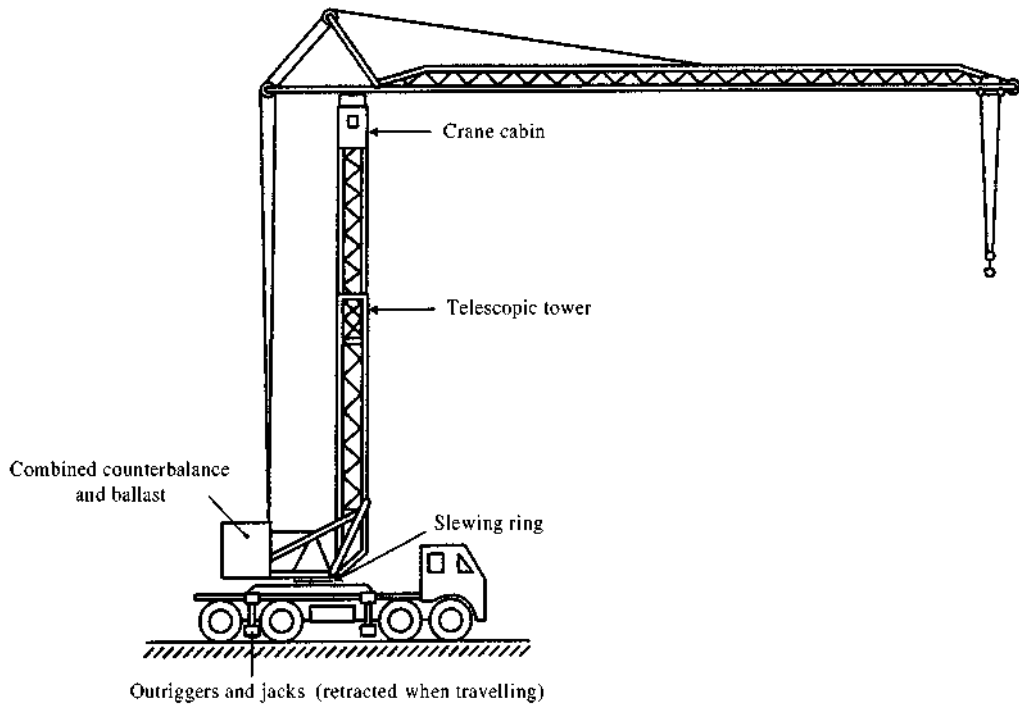


**Fig. 3 Types of static base for tower cranes**

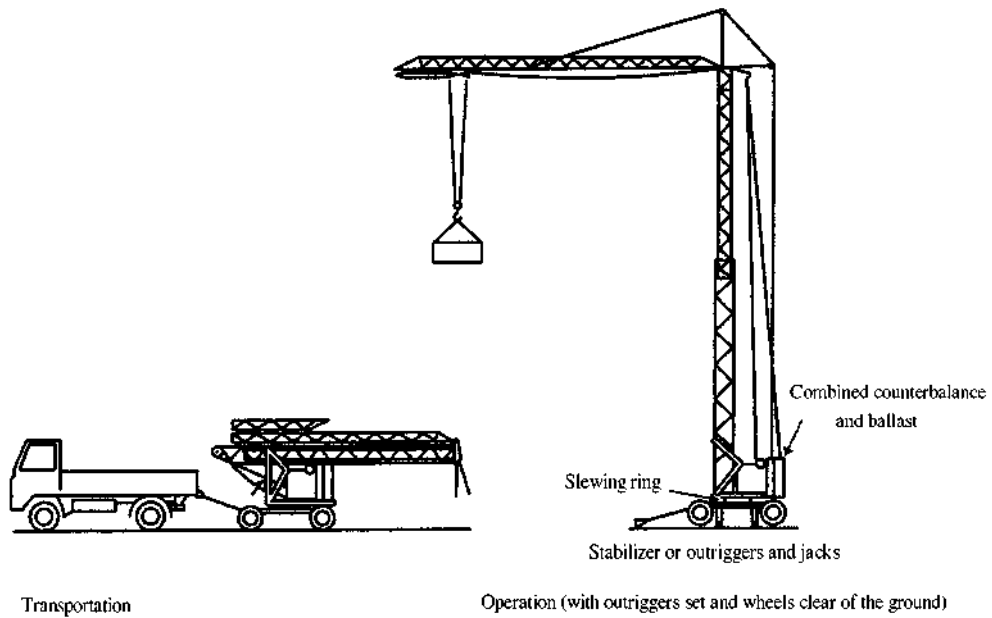


**Fig. 4 Rail-mounted tower cranes**

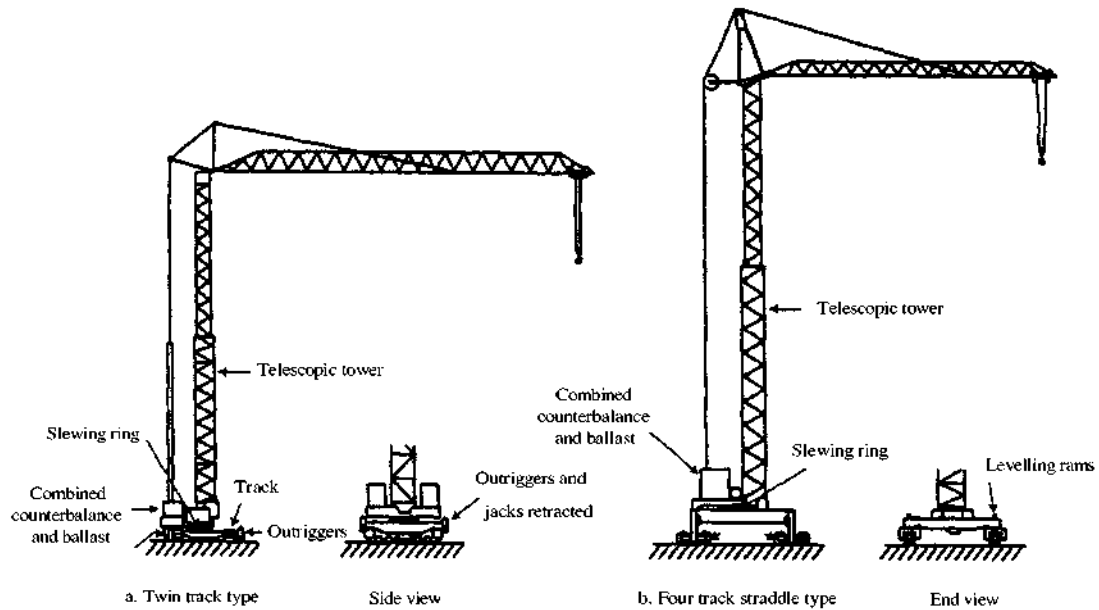




**Fig. 5 Truck-mounted tower crane**



**Fig. 6 Wheel-mounted tower cranes**



**Fig. 7 Crawler-mounted tower cranes**

### 6.3 Operational characteristics

- 6.3.1 The operating characteristics of a tower crane are largely determined by its type of mounting, type of tower and type of jib.
- 6.3.2 A tower crane with a static base only occupies a limited area but is able to cover, from its fixed position, all points at which loads are to be handled within the maximum slewing radius. They can be set at varying heights up to their maximum free standing height. They can also be extended beyond this limit by tying the crane back to the supporting structure.
- 6.3.3 Rail-mounted tower cranes have a larger area of coverage as they can travel along their tracks carrying their rated loads. However, the height requirement should not exceed the free standing height as recommended by the manufacturer. On the other hand, the crane service would be disrupted whenever work must be done on or near the track. The advantage of mobile tower cranes lies in great inward reach without the long jib which would normally be required to reach over the top of the structure.
- 6.3.4 Generally, truck-mounted tower cranes are completely self-contained and can be driven along roads. They are generally capable of comparatively rapid erection and dismantling. They are however generally unable to travel in their fully erected state and cannot handle loads while travelling.

- 6.3.5 Crawler-mounted tower cranes are required to be transported on a low-loader or towed on special road axles when travelling on public roads. Inside the workplace, some can travel over firm, flat, level ground carrying loads up to a specified proportion of their rated loads. They are also able to travel in a partially erected state but without load over unprepared ground provided it is within certain limits of level and compaction.
- 6.3.6 With a horizontal trolley jib, the hook is suspended from the trolley and moves in a horizontal direction when the radius is changed. Unless a luffing jib is equipped with a level-luffing device, the hoist motion will have to be simultaneously operated to achieve level travel of the hook when changing radius.
- 6.3.7 A horizontal trolley jib usually has a smaller minimum operating radius than the equivalent luffing jib and is thus able to handle loads closer to the tower of the crane. For a given height of tower, however, a greater height of lift is available with a luffing jib, and the jib can be raised or lowered to clear obstacles. One advantage of a fixed luff jib is that its extra height at the jib head enables it to clear objects that would obstruct a horizontal trolley jib. The advantage of a rear-pivoted luffing jib is that it has a smaller minimum hook radius than an ordinary luffing jib.
- 6.3.8 For articulated jibs, some designs are not required to weather vane. In this case, the crane is made to withstand storm winds with the jib drawn into minimum radius; there is then no need for a 360° obstruction-free slewing path. One type of this crane has a hinged jib arranged so that the outer portion remains horizontal. As the jib is folded, the outer portion rises, giving increased height and the ability to pass over obstructions.
- 6.3.9 The selection of a crane for any job should be made only after a thorough examination of all the factors involved. In general, it is good practice to select a machine which has a working margin in respect of the load capacity and other anticipated requirements.

## 7. Markings and Documentation

### 7.1 Identification

- 7.1.1 The crane should have a permanent durable plate bearing the manufacturer's name, machine model, serial number, year of manufacture and weight of the unit for identification purpose.
- 7.1.2 Every major structural, electrical and mechanical component of the machine should have a permanent durable plate or a clear indication bearing the manufacturers' name, machine model number, serial number, year of original sale by the manufacturer and weight of the unit. Besides, identification numbers should be clearly marked on all basic removable components and attachments of the machine (such as counterweights etc.) to show that they belong to that machine. It is important that these components should be used only on that machine or identical models or equipment for which they were specifically intended by the manufacturer.

### 7.2 Safe working load charts

- 7.2.1 The crane should have a substantial/durable safe working load chart which:
- (a) has clearly legible characters in English and Chinese and figures displayed inside the crane (Regulation 11(1) of the LALGR); and
  - (b) is easily visible to the crane operator.

### 7.3 Instruction manuals and log book

- 7.3.1 Manufacturer's manuals containing all pertinent data relating to operation and maintenance for the specific model of crane in use must be provided with each machine.
- 7.3.2 The language used in the majority of the workforce in Hong Kong, especially among the shop-floor operations and the middle supervisory staff, is Chinese. It is essential that all the written instructions, the documents and literatures given by the crane manufacturers in relation to the safe use of the cranes (such as the load charts), if not in Chinese, be translated into Chinese so that the operatives have no difficulty in understanding them. Suitable arrangement should also be made to enhance communication in workplace where people would use languages other than Chinese or English.
- 7.3.3 If the equipment is not supplied with a log book then one should be started, maintained and kept at the workplace for the regular, periodic recording of all inspections, tests, repairs, maintenance, and hours of service related to the machine. All entries should be dated and signed by the operator, repairman and supervisor. The crane owner should ensure that the log book remains with the crane and is kept up-to-date throughout the working life of the crane (see section 14 below).

## 8. Operation Features of Tower Cranes

### 8.1 Automatic safe load indicator

8.1.1 All types of crane, except those with a maximum safe working load of 1 tonne or less or those operate with a grab or by electromagnetic means, shall be fitted with an automatic safe load indicator (Regulation 7B of the LALGR). The automatic safe load indicator is usually used in association with overloading cut-out devices which would be further discussed in sub-section 8.8 below. The specification of automatic safe load indicator should conform to British Standard 7262 or equivalent standards.

### 8.2 Brakes

8.2.1 Every brake on the tower crane must be fail-safe type in that the brake will be automatically applied wherever there is a loss of power (pneumatic, hydraulic or electric). These brakes must not be released unless the power has been restored or they are released deliberately.

8.2.2 The application of the brake must have a direct effect on the hoisting drum and as such no belts or chains are allowed between the brake and the drum.

8.2.3 In hydraulic drives using a positive direct system of holding the load, the hoisting brake may be used only as an emergency fail-safe device and its application and torque must be as recommended by the manufacturer.

8.2.4 The brake on the slewing drive must be capable of preventing the jib of tower crane from drifting under a wind pressure up to the maximum operating wind pressure specified by the manufacturers. The brake should be so designed that it can be released so that the jib shall weather vane with the wind when its velocity is greater than that specified by the manufacturer.

### 8.3 Cabins for operators

8.3.1 The operating cabin attached to the structure of the tower crane should meet the following requirements:

- (a) be designed and constructed to protect the operator and the controls from the weather (Regulation 10(1) of the LALGR);
- (b) be provided with a roof of adequate strength to protect the operator from falling objects;
- (c) be properly ventilated by artificial means where necessary;
- (d) vision panels in the floor of cabins or at the operator's feet, in such a position that they may have to withstand all or part of the operator's weight, are guarded, for example by a mesh of adequate strength to carry a person's weight over the area concerned;

- (e) window panels in walls of cabins are protected against being knocked outwards to prevent persons from falling through the aperture;
- (f) every cabin of which the top part may be opened, should be protected to prevent fall of person;
- (g) be fitted with a lock to prevent unauthorized entry when the unit is left unattended, unless the control unit can be separately locked;
- (h) be constructed to give the operator a clear and unrestricted view that will enable him to use the crane safely (Regulation 10(1) of the LALGR);
- (i) have a safe access to and egress from the cabin. The means of access to the cabin should ensure that there is no danger of the operator being trapped in the cabin. Where access is through the floor, there must be sufficient room in the cabin for the operator to stand beside the trap door and raise it without difficulty, and the trap door must be of adequate size;
- (j) have guardrails provided on all outside and access platforms (see Regulation 38B(1) of the CSSR, Regulation 24 of the FIUR). If they are too narrow for guardrails, hand holds, steps or safety lines should be provided at convenient points above the platform;
- (k) have hand holds and steps to facilitate entrance to and exit from the cabin;
- (l) have fire extinguishers of appropriate types and quantities in the cabin; and
- (m) have suitable indicators at or near the cabin.

## **8.4 Operating controls**

- 8.4.1 All controls must be located within easy reach of the operator and allow him ample room for operation. The controls should be of dead man switches in that they return to neutral automatically when released. The main power switch should be lockable and located within easy reach of the operator. Each control must be clearly labelled and marked to show the motion and the direction of movement that it controls. Where practicable, controls should be arranged so that accidental displacement is prevented and inadvertent pressure on them does not cause the crane to be set into motion.

## **8.5 Jib stops**

- 8.5.1 Luffing jib tower cranes, like mobile cranes, require jib stops which will effectively prevent the jib from toppling or being pulled backwards over the tower (see Fig. 8).
- 8.5.2 The jib stop should be the type that combines the functions of disengaging the jib hoist motor and physically stopping the jib as it reaches a predetermined maximum angle.

## 8.6 Guards and protective structures

- 8.6.1 All exposed moving parts of a tower crane such as gears, pulleys, belts, chains, shafts, flywheels, etc. which might constitute a hazard under normal operating conditions shall be effectively guarded (see Regulation 5 of the GOMR).

## 8.7 Electrical supply and equipment

- 8.7.1 Tower cranes connected to electrical supply are fixed installations and shall comply with the Electricity Ordinance (Cap. 406) and the Electricity (Wiring) Regulations (Cap. 406E) (hereafter referred as the EWR). The technical guidelines provided in the Code of Practice for the Electricity (Wiring) Regulations issued by the Electrical and Mechanical Services Department should also be followed. Moreover, the relevant requirements under the Factories and Industrial Undertakings (Electricity) Regulations (Cap. 59W) and other relevant Regulations on electrical safety shall also be observed.

- 8.7.2 The installation of electrical supply for tower crane should conform to the Code of Practice for the Electricity (Wiring) Regulations issued by the Electrical and Mechanical Services Department. The following points should be noted :

(a) *Earthing & Lightning protection*

electrically-operated cranes should have an effective earth connection. In the case of rail-mounted cranes, at least one rail track should be electrically bonded at each joint and the track should be effectively earthed. Crane wheels should not be used for earthing the crane. Besides, all tower cranes should be completely and correctly earthed for lightning protection. Reference should be made to the Code of Practice for the Electricity (Wiring) Regulations issued by the Electrical and Mechanical Services Department, BS EN 13135-1, BS EN 62305, BS 7430 or other equivalent national / international standards;

(b) *Supply voltage and supply phase sequence*

before connecting the tower crane to an electrical supply, it should be ensured that the supply voltage characteristics and supply phase sequence correspond with those of the crane equipment. Special attention should be paid to voltage variation (drop) when electrical power is supplied by temporary generator sets at construction sites;

(c) *Connections*

when practicable, the electrical supply to a travelling tower crane should be provided through a cable winding drum or a properly installed, insulated and protected collector system. If a trailing cable is used, it should be mechanically protected, such as with armour wire, an incorporate and earthing core, and should be suitably terminated at each end. Care should

be taken to ensure that the trailing cable is not damaged during operational movement or when the crane is travelling; and

(d) *Isolation*

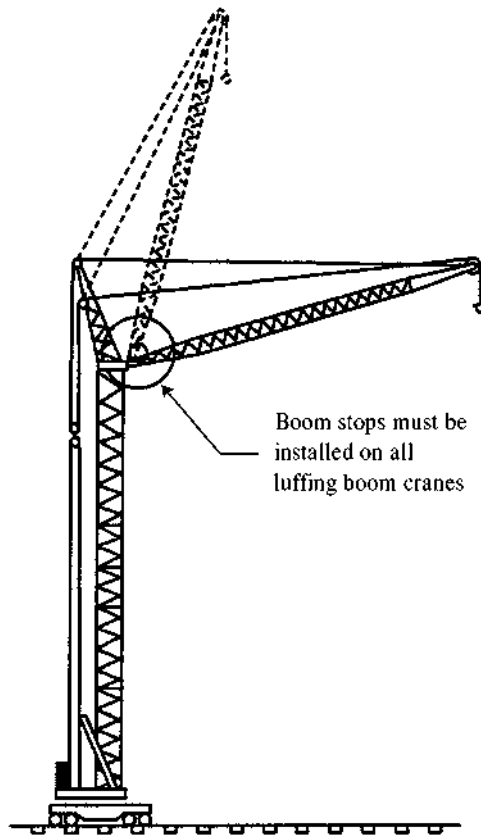
in addition to any isolator within the crane capable of cutting off the electrical supply to crane motions, there should be an isolator remote from the crane which can be used to cut off the supply to the crane itself. Regulations/procedures should also be available to prevent inadvertent reclosure or mal-operation of the isolator at the remote end.

- 8.7.3 All electrical components must be well bonded to the cranes' structure which must in turn be connected to an effective earth. All electrical equipment and connectors must be weatherproof. Strain-relief connectors should be used at the connection of the power cable to the crane tower connection in order to protect the power cable. Power cables which run inside the crane tower must be securely fastened at regular intervals. The earthing connections of the electrical installations of tower crane should conform to the Code of Practice for the Electricity (Wiring) Regulations issued by the Electrical and Mechanical Services Department.

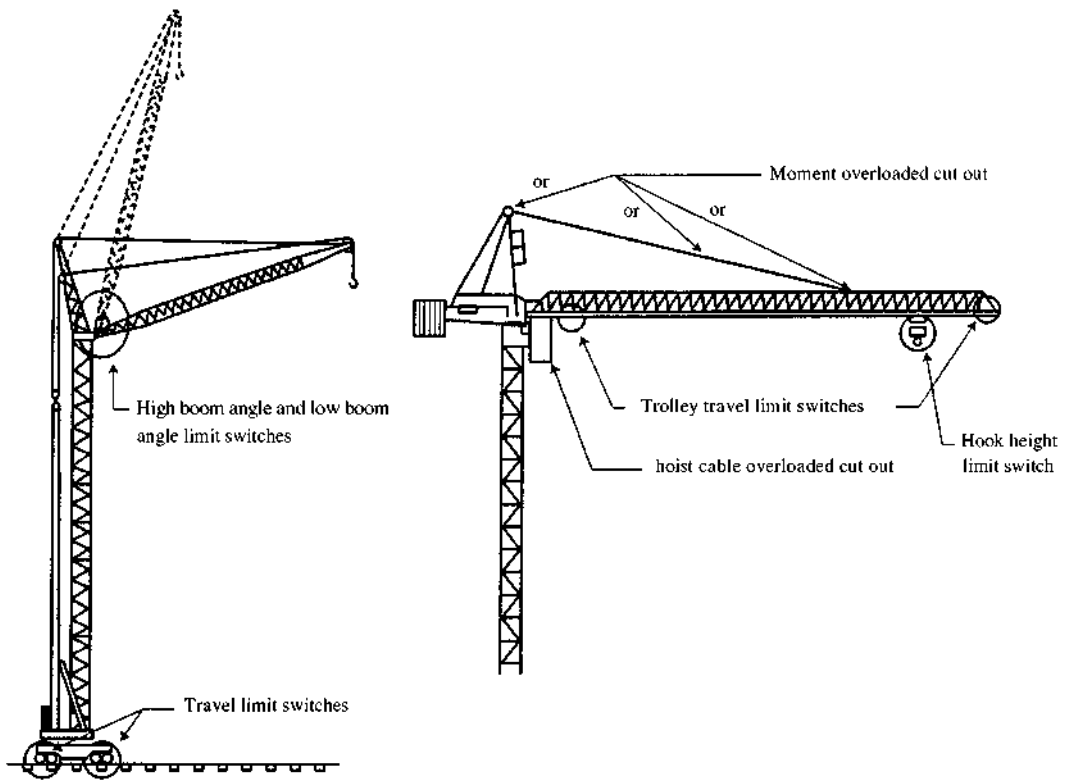
## 8.8 Limiting switches

- 8.8.1 All tower cranes of every configuration must be equipped with built-in safety devices which operate automatically to prevent damage to the machine should the operator make an error. The most important of these are the limit switches which would eliminate the possibility of crane overload or over-travel of crane components (see Fig. 9).
- 8.8.2 Every tower crane must have -
- (a) a hook height limit switch that causes the hoist drum to stop whenever the load hook reaches a predetermined maximum height position;
  - (b) luffing jib limit switches that cause the jib hoist drum to stop whenever the jib is raised to too high an angle or lowered to too low an angle. These switches should be adjusted by raising up and lowering down slowly (without load) and allowing the jib to come in contact with the striker switches;
  - (c) a trolley travel limit switch that causes trolley motion to stop whenever the trolley reaches a predetermined maximum out or maximum in position;
  - (d) an overload limit switch that causes the hoist drum to stop whenever the load being hoisted exceeds the maximum rated load for any radius or jib angle or whenever the over-turning moment exceeds the rated load moment. The overload limit switch should be installed in association with the automatic safe load indicator; and
  - (e) travel limit switches for rail mounted cranes that apply the carriage brake whenever the crane comes near the ends of the tracks.





**Fig. 8 Jib (Boom) stop**



**Fig. 9 Tower crane limit switches**

## 9. Siting of Tower Cranes

### 9.1 General

- 9.1.1 In siting a tower crane for operation, particular attention should be paid to two factors: the crane standing or support conditions and the presence of proximity hazards. Consideration should also be given to the projection of the tower crane beyond the site boundary to avoid potential hazards to the public including those in private areas and public areas.
- 9.1.2 It is essential that the maximum pressures or forces which can be exerted by the tower crane on the ground or on other supports and tie frames are known. Tower crane manufacturers should provide this information or give a method and data from which it can be calculated.
- 9.1.3 Particular care should be taken in the assessment of wind headings, both operational and out-of-service. High winds exert considerable forces on tower cranes which are often sited in the vicinity of tall buildings. In such conditions, a generous allowance should be made for local wind pressures of high intensity due to funnelling (or venturi) and gust effects. Particular care should be taken in the design and details of all supporting structures, connections and anchorages.

### 9.2 Crane standing or supporting conditions

- 9.2.1 The ground or foundations, temporary supporting structures, grillages, packings, connections and anchorages for tower cranes should be of sufficient strength to withstand the maximum in-service and out-of-service loadings without failure. In particular, suitable preparation of ground surface for fixed tower cranes should be carried out for safety reason.
- 9.2.2 It is essential that the ground on which a tower crane stands has adequate bearing capacity. In assessing this, account should be taken of seasonal variations in ground conditions. The bearing capacity must not be exceeded under the most severe static and dynamic crane loading conditions. In a similar fashion, consideration must be given to the structural strength and stability whenever the unit is supported on or by any structure.
- 9.2.3 The siting of the crane, the assessment of maximum loads and the design of foundations, supporting structures and ancillary details should be certified by a safety supervision personnel. Particular care should be taken to ensure that the imposed loadings are not underestimated. Careful assessment of probable wind pressures should also be made, taking into account the degree of exposure of

the site and any other special factors. For construction site, when the installation of the tower crane may have effect on the permanent structure by way of overstressing or overloading, the safety supervision personnel should submit the certified plan, design information and/or method statement of the works to the project engineer and certify the completion of work.

9.2.4 For the design of wind load on structure of tower cranes, reference can be made to the Code of Practice on Wind Effects in Hong Kong issued by the Buildings Department. As most of the tower cranes used in Hong Kong are imported from European countries where the design wind loads are much lower than that of Hong Kong, the wind loadings on the structure of tower cranes should be checked in accordance with the above mentioned Code of Practice. Crane manufacturer's data relating to the dead weight of the tower crane and the dynamic forces, which can occur during operation of the crane, should always be obtained for determining the most critical effects of the wind loading, taking into consideration of the above-mentioned Code of Practice.

9.2.5 Although tower crane manufacturer's instructions may specify maximum wind speed for service conditions, they cannot give recommendations for survival wind conditions on a particular site. On tall cranes, wind forces will have a considerable influence on the strength requirements of the supports and foundation. Due care is necessary in the fitting-up and fixing of any holding-down devices, rail clamps, temporary connections or anchorages.

9.2.6 The construction of the connections between the tower crane and the building works affected should comply with the Building (Construction) Regulations (Cap. 123B). The design should be certified by a safety supervision personnel. The structure and all crane anchorages should be sufficiently strong to carry the maximum loads that the crane may exert upon them under the most severe static and dynamic crane loading conditions. This is particularly important where the use of a climbing crane is contemplated. For construction site, when the installation of the tower crane may have effect on the permanent structure by way of overstressing or overloading, the safety supervision personnel should submit the certified plan, design information and/or method statement to the project engineer and certify the completion of work.

9.2.7 Underground hazards

Cranes should not be sited where there is danger to their foundations, supporting structures from cellar whether filled or not, temporary shoring, excavations, embankments, buried pipes and mains, and etc. With these underground hazards, it may be necessary to provide additional special foundations to ensure the safety of the crane.

9.2.8 Tidal or flood water areas

In areas subject to tidal or seasonal flooding, or where there is a high water table, the crane may require deep foundations or special ground consolidation. In such situations, all machinery and electrical equipment should be positioned where it is not in danger from any rise in the water level. Unless adequate precautions are taken, the crane should not be sited where there is danger to foundations, rail tracks or temporary access roads from surface water drainage, flooding or rises in the water level.

9.2.9 Gradients

The bases for static tower cranes and the tracks for rail-mounted tower cranes should be firm and level. Truck and crawler-mounted tower cranes have a very limited ability to travel and operate on sloping ground. In all cases where the instruction handbook for the crane does not specify the limit of slope which the crane can traverse, the manufacturer should be consulted.

**9.3 Proximity hazards**

9.3.1 Tower cranes should be sited where there is clear space available for erection, operating and dismantling. Consideration should be given to the proximity hazards such as overhead electric lines and conductors, power cables, radio frequency wave transmitting tower, nearby structure and building, hoists, stacked materials, other construction works, the flight paths of airfields, the route of aerial ropeway and other cranes, public access areas including highways and railways, etc.

9.3.2 Tower cranes must be located so that there is at least 3m (10 feet) clearance between the end of boom and the nearest obstacle or building. In some situations, aircraft warning lights should be fitted to the top of tower cranes. As far as possible, tower cranes should be sited to avoid loads being handled over occupied premises, highways, the route of aerial ropeway, other construction works, or railways. The danger to or from underground services, such as gas mains or electric cables, should not be overlooked. Precautions should be taken to ensure that the tower crane standing is clear of any underground services. Where this is not possible, the services should be adequately protected to safeguard against any damage.

9.3.3 Overhead electric lines and cables

9.3.3.1 Fatal accidents may occur when a crane comes into contact with or near to overhead electric lines or cables. Where a tower crane has a chance of coming close to any live overhead electric lines or cables, the crane owner should liaise with owners of the overhead lines, e.g. the power companies, to work out the

exact safety requirements and devise the safe work plans. Reference should be made to the Electricity Supply Lines (Protection) Regulation (Cap. 406H) and the Code of Practice on Working near Electricity Supply Lines issued by the Electrical and Mechanical Services Department.

9.3.3.2 All overhead lines or other electric apparatus should be treated as live unless declared dead and safe by the relevant authority.

9.3.3.3 Any person working in the vicinity of any electricity supply line should be properly trained and instructed to ensure that they are capable of taking necessary safety measures and safe system of work.

9.3.3.4 When working parallel to overhead power cables, a string of warning markers should be erected at a safe distance from the cables. The string should be supported on posts at convenient intervals and each post should carry the warning notice stating:

**‘DANGER! OVERHEAD ELECTRIC LINES!’**

**「危險！架空電纜！」**

9.3.3.5 A crane should not be operated in the vicinity of overhead electric lines unless guided by an experienced slinger or signaller. The crane operator should always try to keep the overhead electric lines in view when maneuvering the crane. It is worthwhile to note the difficulty to estimate the heights or distances of the lines by normal methods of observation.

#### 9.3.4 Anti-collision

9.3.4.1 When two or more tower cranes are installed within a limited area, their action zones may overlap and give rise to danger of collision. The collision may be resulted from the coming into direct contact between the structural members of cranes, the rotating jib of a crane installed at lower position striking onto the hoisting rope of a higher crane or its suspended load. The hoisting rope of a crane may entangle with certain part(s) of another crane. The best solution is to eliminate any overlapping or interference zones as far as possible from both the standpoints of safety and smooth lifting operation.

9.3.4.2 The risk of collision should be properly considered during the establishment of the safe system of work (see section 3 above). Particular attention should be paid to the effects on movement amplitudes of the jibs and their suspended loads. The movement would be affected by the rotating speeds of the jibs and their respective braking actions, inertia of the pedant loads, under hook heights, sizes of the loads being handled and the wind situations.

- 9.3.4.3 Where two or more cranes are positioned in the same or different workplaces in such a way that there is a risk of collision or rope entanglement, the following safety measures, among other things, should be taken:
- (a) a responsible person should be appointed for the overall control of the lifting operations in a workplace;
  - (b) for lifting operations performed in overlapping zone between different workplaces, good communication and co-ordination between the different workplaces' responsible persons on the lifting operations should be maintained;
  - (c) as far as practicable, every crane operator should have a clear view of the whole of the overlapping zone(s) of the tower crane he operates;
  - (d) an effective communicating system solely used by these cranes should be provided for the lifting operations. The system should be free from interference and should allow direct communication between the two crane operators;
  - (e) weather vane operation should remain possible and adequate arrangement should be made so that weather vane operation will not give rise to any collision or physical contact between any two cranes;
  - (f) suitable working space limiters complying with BS EN 12077-2 or equivalent should be provided to ensure only one tower crane remaining in the overlapping zone at any time. Alternatively, a suitable anti-collision system which can allow more than one tower crane in the overlapping zone without causing any collision should be provided. Responsible persons of different workplaces should coordinate for the installation of suitable working space limiters or anti-collision systems for the cranes operating in the overlapping zones between the workplaces;
  - (g) every working space limiter or anti-collision system provided in item (f) above should be properly installed and maintained;
  - (h) if anti-collision system is adopted, the manufacturer's instruction manual containing all the information regarding the correct installation, calibration, testing, inspection, maintenance and use of the anti-collision system should be followed;
  - (i) no tower crane should be put into use unless the set up of the working space limiter(s) or anti-collision system, as appropriate, has been properly tested. Further test is also required on every occasion where there is any modification, adjustment or alteration of crane/workplace parameters such as alteration of crane height, etc;
  - (j) the record of testing should be kept in the workplace office and be available for inspection; and

- (k) where it is necessary to temporarily suspend the safety functions of the working space limiters or anti-collision system, e.g. for set up, adjustments, testing, maintenance or repair, all the crane movements in the overlapping zone should be under direct supervision of the responsible person who is in direct contact with all operators and personnel associated with the crane operations in a workplace. If the suspension of the safety functions affects other workplaces' crane operations, co-ordination on the lifting operations in the overlapping zone should be made between the responsible persons of the workplaces to avoid collision.

9.3.4.4 Every working space limiter provided under sub-paragraph 9.3.4.3 (f) above should be so designed that:

- (a) its specification is compatible with the design and safe use of the tower crane. Its operation should not have any adverse effect on the crane. It is therefore important that prior consent or approval should be sought, where practicable, from the crane manufacturer before the safety device is installed;
- (b) it is directly actuated mechanically or electro-mechanically;
- (c) after it has been triggered, put the tower crane in a safe state and prohibit its movement in the dangerous direction;
- (d) it shall fail to a safe condition when a failure or malfunction occurs;
- (e) any switch for temporarily suspension of its safety functions (e.g. for set up, adjustments, maintenance and repair) is housed in a separate switch box. The switch box should be kept locked during normal crane operation with the key being kept by the responsible person;
- (f) it is capable of withstanding the shock loads and vibrations created during the normal usage, erection, rope changing, dismantling, transportation and maintenance; and
- (g) its designated safety functions can be verified during inspection or testing.

9.3.4.5 The anti-collision system provided under sub-paragraph 9.3.4.3 (f) above should be so designed that:

- (a) its specification is compatible with the design and safe use of the tower crane. Its operation should not have any adverse effect on the crane. It is therefore important that prior consent or approval should be sought from the crane manufacturer before the safety device is installed;
- (b) it is capable of tracking accurately the locations of all the cranes within the overlapping zone under the system including their jib movements, trolley movements and hook movements;
- (c) it is capable of intervening automatically on the crane mechanisms for ensuring no collision will take place by slowing down the speed of or

- stopping crane movement, as appropriate, whenever there is a risk of collision;
- (d) after the triggering of a motion limiter, to put the tower crane and its movement in a safe state;
  - (e) a continuous audible and visual signal is given out at each operator's cabin to remind the operator to slow down a crane movement when approaching a zone with a risk of collision;
  - (f) internal audible and visual warnings are given out at each operator's cabin when the anti-collision system fails or is over-ridden. The warning signals should be distinctive and continuous;
  - (g) at least one flashing-light warning signal actuated when the anti-collision system fails or is over-ridden, distinguishable under all conditions such as bright sunlight and conspicuous to other crane operators and personnel in the surroundings, is provided outside each operator's cabin;
  - (h) each type of warning signals provided is distinguishable from all other warning signals of the tower crane;
  - (i) it provides display panels positioned in such a manner that every crane operator had a clear view of the indications and warnings given on the panel. The display panel should not interfere with the operator's view of the load and its surroundings. Glare-free illumination displays should be provided and the information given should be clearly distinguishable under all conditions such as bright sunlight;
  - (j) every limiter is directly actuated mechanically or electro-mechanically;
  - (k) it shall fail to a safe condition when a failure or malfunction occurs;
  - (l) any switches for temporarily suspension of its safety functions (e.g. for set up, adjustments, maintenance and repair) is housed in a separate switch box. The switch box should be kept locked during normal crane operation with the key being kept by the responsible person;
  - (m) it is capable of withstanding the shock loads and vibrations created during the normal usage, erection, rope changing, dismantling, transportation and maintenance;
  - (n) every component likely to be affected by the weather is weatherproof; and
  - (o) its designated safety functions can be verified during inspection or testing.



## 10. Erection, Dismantling and Height Alteration

### 10.1 General precautions

10.1.1 Accidents may occur during crane erection, dismantling and height alteration operations due to failure to follow the correct procedures specified by the crane manufacturers, use of incorrect parts, the wrong size or type of bolt, the incorrect assembly or sequence of assembly, or taking apart of components. To avoid dangerous and expensive consequences, the following points should be observed:

- (a) the owner should arrange to conduct a risk assessment before the commencement of any erection, dismantling or height alteration operation on tower crane to identify the hazards inherent in the operation and the hazards which could result from adjacent activities, the risk assessment should be conducted in accordance with the details summarized in Annex 1;
- (b) the owner should formulate measures for avoiding the hazards identified in risk assessment, or where this is not possible, devise measures for minimizing their likelihood of occurrence or mitigating their consequences. These measures include but not limited to the following:
  - (i) installation of fall protection system for workers working at height;
  - (ii) suspension of work activities within an exclusion zone around the tower crane until an operation is completed;
  - (iii) provision of personal protective equipment such as protective gloves, ear protectors and reflective vests;
  - (iv) sufficient rest breaks;
  - (v) provision of proper training for competent person and workmen engaged in tower crane erection, dismantling or height alteration operations;
  - (vi) provision of adequate lighting between floors; and
  - (vii) ensure the work is carried out by competent workmen and competent person as described in sub-section 10.5 and 10.4 below respectively;
- (c) the owner should prepare a method statement in Chinese to define the procedures for the tower crane erection, dismantling and height alteration operations. Suitable arrangement should be made to enhance communication in workplace where people would use languages other than Chinese. If competent specialist contractor as described in sub-section 10.3 below is employed for the erection, dismantling or height alteration operation, the method statement should be prepared jointly with such competent specialist contractor. The method statement should cover but not limited to the following:
  - (i) all measures for avoiding or mitigating the hazards identified in the risk assessment;
  - (ii) step-by-step procedures supplemented by diagrammatic illustrations;
  - (iii) highlighting of critical hazards and safety precautions by specific warning words such as “Danger”, “Caution” and “Hold Points”;

- (iv) procedure and instruction on dealing with “Hold Points” of critical parts;
  - (v) procedures for avoiding hazards to personnel working adjacent to the tower crane;
  - (vi) clear statements on the role and tasks of members of the working crew; and
  - (vii) arrangements for effective communication;
- (d) an exclusive zone is required which has been clear of other personnel not involved and stacked materials, etc. The area should be large enough to permit the components to be stacked and handled, and the crane to be erected or dismantled without interfering with or risking the other workplace personnel. Sufficient area must be set aside for the mobile crane or other lifting appliance that will be used to erect/dismantle the tower crane. Provisions must be made for good access for trucks delivering or taking away the components. Adequate lighting should be provided for all these working areas;
- (e) if applicable, copies of risk assessment report (including the method statement) should be distributed to the competent specialist contractor as described in sub-section 10.3 below, who should be advised of the estimated duration of the operation and the boundaries of the exclusion zone;
- (f) if practicable, erection, dismantling or height alteration operation during night time should be avoided;
- (g) most manufacturers specify limiting wind velocities for the erection, dismantling and height alteration operations, and these operations should not be undertaken in high wind speeds. Particular care should be taken in gusty conditions and where there are shielding and funnelling (venturi) effects in the vicinity of tall buildings;
- (h) assemblies should be slung from the points recommended by the manufacturer and in such a way that they will not swing or become unstable or sustain damage when lifted;
- (i) if concrete is used for crane foundation, ballast or counter balance, it should be of the correct mix, and given sufficient curing time to attain an adequate strength. At each stage of the erection, dismantling or height alteration operation, care should be taken to ensure that the correct amount of ballast and/or counterbalance is in the appropriate position on the crane in accordance with the manufacturer's instructions;
- (j) on all cranes capable of height extension, with the increase in under-hook height, care shall be taken to ensure that there is sufficient rope to give at least two full turns on the hoist drum (Regulation 17 of the LALGR). In this respect, special care shall also be taken when the hook is required to work below ground level;

- (k) some erection procedures require part or all of the electrical installation to be in service during the erection operation. In such cases, electric work should be carried out by a qualified electrical worker registered with EMSD under Electricity Ordinance (Cap. 406). He will ensure that all power is isolated whilst the electrical system is being worked on, that the earthing arrangements are adequate, that the voltage of supply matches that of the crane and that all circuits are tested before being energized. In some cases it may not be possible to adjust limit switches with the power off but this should be done as soon as practicable and in any case before the crane is released for service;
- (l) the owner should have obtained the following documents before proceeding with the erection or height alteration operation of a tower crane or a derrick crane (if it is used for assembling or dismantling the tower crane):
  - (i) report on verification of components;
  - (ii) report on pre-delivery checking;
  - (iii) report on assessment of supporting structure (where applicable);
  - (iv) maintenance logbook recording the maintenance and inspection history of the crane;
  - (v) report of the risk assessment for the operation including the method statement; and
  - (vi) records of the qualifications and experience of the supervising engineer and the competent person responsible for the operations; and
- (m) the owner should ensure that mobile cranes and derrick cranes used in the erection, dismantling and height alteration operations of tower crane had been tested and examined. Relevant certificates had been obtained and available for inspection.

## **10.2 Appointment of supervising engineer**

10.2.1 The owner should appoint a supervising engineer as described in sub-section 10.2.3 below in writing to directly supervise on site the erection, dismantling and height alteration operations of tower crane. The supervising engineer should conduct a briefing session with the competent person, the safety professional, the crane operator and other associated working crew to discuss on the whole process of the operation and to ensure a safe system for the operations including the working procedures, checklists and programme. Upon completing of each operation, the supervising engineer is responsible for certifying the completion of such operation.

10.2.2 The appointment letter of supervising engineer should mention the model of tower crane at the workplace and its identification and workplace location. The appointment letter is valid on workplace basis. Details of appointment of the

supervising engineer with his/her name and contact phone number should be clearly posted up at the prominent place near the tower crane.

10.2.3 The supervising engineer so appointed should have the following qualifications, experience and competencies to control, monitor and supervise the erection, dismantling and height alteration operations on tower cranes :

- (a) an engineering degree of relevant discipline or an engineer with the qualification of registered professional engineer/Member of Hong Kong Institution of Engineers or equivalent;
- (b) not less than four years of related working experience (this requirement to be effective from 1 July 2013). One year of related working experience means 1 erection, 4 telescoping/climbing and 1 dismantling in 12 months;
- (c) capability in administering the critical hazards and safety precautions specified in the method statement prepared by the owner for the erection, dismantling or height alteration of tower crane on critical parts;
- (d) capability in communicating with the competent person and the crane operator throughout the erection, dismantling and height alteration operation and is empowered to stop work if necessary; and
- (e) capability to conduct a visual inspection on the parts of a tower crane to ensure that they are in good working order before commencement of any operations.

### **10.3 Appointment of competent specialist contractor**

10.3.1 If erection, dismantling or height alteration work of a tower crane is carried out in a construction site or a contractor is employed by the owner of a workplace for such work, the owner should ensure the work is only carried out by a competent specialist contractor as described in sub-section 10.3.2 below.

10.3.2 Competent specialist contractor for erection, dismantling and height alteration operations of a tower crane should possess the following qualifications and experience:

- (a) registered on the specialty of “Erection, Dismantling and Climbing” of the Tower Crane trade on the Voluntary Subcontractor Registration Scheme (the VSRS) administered by Construction Industry Council to execute tower crane operations;
- (b) possess relevant experience and sufficient technical capability and have at least one (1) competent person and three (3) senior workmen with appropriate skills and experience as described in sub-sections 10.4 and 10.5 below respectively; and
- (c) able to understand the method statements for tower crane erection,

dismantling and height alteration operations and to explain the details to his working crew including full explanation on the risks associated with improper working procedures and those safety hints and precautions set out in the warning/attention sections of the method statement such as those marked “Caution”, “Danger” or “Hold Points”.

#### **10.4 Competent person for erection, dismantling or height alteration of tower crane**

10.4.1 The owner should ensure erection, dismantling and height alteration operations of tower crane are carried out under the supervision of a competent person. (Regulation 7H of the LALGR)

10.4.2 The owner should ensure that the competent person supervising erection, dismantling or height alteration operations of tower crane should possess the following qualifications and experience:

- (a) registered skilled worker of the trade “To carry out erection, dismantling, telescoping/climbing of a tower crane, and the hoisting of materials, tools and equipment related to the aforesaid work” under the Construction Workers Registration Ordinance (Cap. 583) (hereafter referred to as CWRO) (this requirement is effective from 12 months after the commencement of the registration of the trade);
- (b) at least 10 years of relevant experience;
- (c) experience in erection, dismantling and height alteration of tower crane in the same model line, or completion of familiarization training on the same model line;
- (d) completion of the following courses:
  - (i) Safety Training Course For Construction Workers of Specified Trade (Silver Card Course) – Tower Crane Worker (Erecting, Dismantling, Telescoping & Climbing) (“EDTC Course”) offered by the Construction Industry Council Training Academy (CICTA); and
  - (ii) Training for Tower Crane Competent Person (Erecting, Dismantling, Telescoping & Climbing) offered by CICTA; and
- (e) completion of Certificate Course with Imbedded Certification Test for Derrick Crane Operator offered by CICTA if he is in-charge of erection or dismantling of a tower crane using derrick crane.

10.4.3 The competent person should be able to:

- (a) brief and instruct his crew to execute the operation in accordance with the method statement;
- (b) draw the attention of his crew to important safety warnings and precautions stipulated in the manufacturer’s manual, method statement, critical parts

checklist and risk assessment report (in particular the parts marked such as “Danger”, “Cautions” and “Hold Points”);

- (c) respond to questions raised by his crew members and provide appropriate directives to them; and
- (d) conduct visual inspection to ascertain the integrity of key components of the tower crane prior to commencement of the operation.

## **10.5 Competent workmen for the erection, dismantling or height alteration of tower crane**

10.5.1 The owner should ensure erection, dismantling and height alteration operations of a tower crane are only carried out by competent workmen having the qualifications and experiences as described in sub-section 10.5.3 below.

10.5.2 All erection, dismantling and height alteration operations should only be carried out by competent workmen under the supervision of a competent person and monitored by a supervising engineer.

10.5.3 Competent workman means either senior workman or junior workman with the following experience and qualifications:

(a) Senior workman

senior workman should be a Registered Skilled Worker of the trade “To carry out erection, dismantling, telescoping/climbing of tower crane, and the hoisting of materials, tools and equipment related to aforesaid work” under the CWRO (this requirement is effective from 12 months after the commencement of the registration of the trade) and have at least 4 years of related experience. He should also have completed the Safety Training Course for Construction Workers of Specified Trade (Silver Card Course) – Construction Materials Rigger (“Rigger Course”) and EDTC Course organized by CICTA.

(b) Junior workman

junior workman should be a Registered General Worker under CWRO. He should only work under the direct one-to-one supervision of a senior workman. He should have completed the Rigger Course organized by CICTA.

## **10.6 Manufacturer’s instruction**

10.6.1 It is essential that crane manufacturer's instructions for erection, dismantling and height alteration operations should be strictly adhered to. Any departures from the specified procedures may impose excessive loadings on structural and mechanical parts leading to a failure or collapse of the crane. It should always be ensured that -

- (a) the manufacturer's instruction book is available to the crews who carry out the erection, dismantling and height alteration operations of the tower crane;
- (b) the correct instruction book, appropriate to the particular crane, is used (this should bear the manufacturer's machine serial number and the owner's plant number);
- (c) the supervising engineer should conduct a briefing session with the competent person, safety professional, the crane operator and other associated crews on the prescribed procedures to ensure a safe system of work including working procedures prescribed by the manufacturer, checklists, programme and the method statement as described in sub-section 10.1.1 (c) above;
- (d) approval has to be obtained from the crane manufacturer before any departure is made from the prescribed procedures; and
- (e) only correct parts and components are used.

## **10.7 Pre-delivery checking**

- 10.7.1 The owner of a tower crane should ensure pre-delivery checking of a tower crane has been carried out by a competent examiner before it is delivered onto a workplace.
- 10.7.2 The owner should ensure the following reports on pre-delivery checking have been certified by the competent examiner and issued for checking by the owner before erection of a tower crane:
  - (a) report on pre-delivery verification of components; and
  - (b) report on pre-delivery checking
- 10.7.3 The reports on pre-delivery checking are valid for no more than 12 months after certification by the competent examiner.
- 10.7.4 Procedures for the pre-delivery checking including the pre-delivery verification of components are summarised in Annex 2.
- 10.7.5 Pre-delivery checking and issuance of report on pre-delivery checking by competent examiner is required for any additional mast sections used for mast height alteration and any replacement motors for the telescopic cage.
- 10.7.6 The results of the pre-delivery checking on a telescopic cage and its associated hydraulic system for height alteration operation by a competent examiner should make reference to the tower crane for which the telescopic cage will be used. The report on pre-delivery checking of telescopic cage is valid for no more than 12 months, including the period for which the telescopic cage is stored at the workshop and re-delivered to the workplace for use.

- 10.7.7 The telescopic cage can also be used for other tower cranes on the same workplace provided that a copy of the existing report on pre-delivery checking of the telescopic cage is attached with the report on pre-delivery checking of tower crane for the other tower cranes. If the telescopic cage is transferred to another workplace, a further pre-delivery checking and issuance of report on pre-delivery checking of telescopic cage by competent examiner will be required.

## **10.8 Provision of foundations, rail tracks and temporary roads**

### **10.8.1 Static cranes, expendable in-situ base**

The design and construction of the foundation should be certified by a safety supervision personnel. Corner angles, frames or expendable cast-in sections, should be accurately positioned and rigidly held by the base section of the tower or appropriate jig during concreting and curing. Frequent checks of position and plumb should be made. Provision should be made for the inspection of the tie down bolts. Drainage should also be provided to prevent the collection of water around the crane foundation. For construction site, when the installation of the tower crane may have effect on the permanent structure by way of overstressing or overloading, the safety supervision personnel should submit the certified plan, design information and/or method statement of the works to the project engineer and certify the completion of work.

### **10.8.2 Static cranes, on own base (without bogies or wheels)**

The design and construction of the foundation should be certified by a safety supervision personnel. Holding down devices should be accurately positioned. The top surface of the foundation should have a level surface. Means should be provided for the inspection of holding down devices, and for preventing the collection of water around the crane base.

### **10.8.3 Rail-mounted cranes, tracks**

- 10.8.3.1 The track is of extreme importance to the safe operation of the cranes. It should be designed by a professional engineer with relevant qualifications and experiences. Every track should be regularly inspected. The track should be level, secured to foundations or sleepers of adequate strength, and spaced adequately to take the maximum applied wheel pressure and designed to suit the safe allowable bearing pressure on the ground. The track bed and track must be laid in accordance with the manufacturer's specifications for grading, tie-spacing and rail weight.

- 10.8.3.2 The rails should be flat bottomed, of no less sectional area than recommended by the crane manufacturer. Care should be taken in setting the tracks, and the correct curve radii used for curve going or non-curve going bogies. Adjacent ends of rail should be tightly butted. Rail ties or the tie bars are used to maintain



the correct gauge. They should be able to withstand compressive as well as tensile forces. Holes for fish plates and rail ties should be located over sleepers.

- 10.8.3.3 The rail of the track should be effectively earthed as stated in sub-section 8.7.2 (a) above and maintained in a clear condition. Crane wheels should not be used for earthing the crane.
- 10.8.3.4 Travel limit switches, sand-boxes and stops should be positioned in that order towards the end of the track, so that in the event of the crane over-running the switches, its travelling inertia will be largely reduced by the sand boxes before it comes against the stops. The stops should be in-line, at a distance of half the crane base from the ends of the track, or some other measures should be taken to ensure that the permissible ground bearing pressure beneath the ends of the track is not exceeded. On bad ground, longitudinal bearers can be used to minimize rail deflections. The use of flame cutting equipment for cutting rails and for making holes for bolts and rail ties is not recommended since it destroys the heat treatment of the rail and produces local hard areas where cracks can develop.
- 10.8.3.5 All bogies of the travelling under carriage should be fitted with rail clamps which can be firmly attached to the rails to lock the crane in position after the crane is closed down at the end of the working shift and during high winds. Where vehicles have to cross or travel over tower crane track, the track should be adequately protected by sleepers and hard core, or other covering material.

#### 10.8.4 Climbing cranes, supporting structure

- 10.8.4.1 Assemblies for transferring the load from the crane onto the supporting structure should be designed and certified by a safety supervision personnel who should check that with the particular fixing centres and tower height employed, the structure is able to withstand the maximum combination of static and dynamic loadings that may be applied to it by the crane. For construction site, when the installation of the tower crane may have effect on the permanent structure by way of overstressing or overloading, the safety supervision personnel should submit the certified plan, design information and/or method statement of the works to the project engineer and certify the completion of work.
- 10.8.4.2 Concrete structures should be sufficiently cured before having crane loads imposed upon them, and that the manufacturer's instructions are closely followed in respect of the total height of the crane, and the support centres to be used in relation to the height projecting above the top support.
- 10.8.4.3 Floor openings in the structure to accommodate the tower of the crane should be of adequate size to give sufficient clearance between the tower and a climbing frames and any protruding reinforcement.

10.8.4.4 If the crane is first used on a fixed base, care should be taken at the time of installation to ensure that the tower is correctly orientated, that the climbing equipment is correctly positioned and attached, that the beams supporting the crane be absolutely level to ensure that the tower is supported on both beams and at both sides of the tower, and that the crane is securely held by the climbing frames before the bolts attaching it to the base are released. All wedges should be secured to prevent them from working loose and falling out during operation.

10.8.4.5 The supporting frame or bearing platform of a tower crane erected in H-corridor, concrete turnbuckle, river channel and at sea should follow the original design as far as possible. If the use of non-original design is necessary, the safety supervision personnel is required to design and certify the plans and re-submit for verification by the project engineer.

#### 10.8.5 Truck, trailer and crawler-mounted tower cranes

Temporary access roadways or work plateaux provided for these machines should be of adequate surface quality and load bearing resistance, properly consolidated, and level to within required limits. Strict limitations on the use of truck, trailer and crawler-mounted tower cranes on slopes, and the manufacturer's instructions should be followed. It is recommended that these types of tower crane are fitted with a level indicator which is conveniently positioned and is sufficiently accurate to enable the crane to be set correctly.

### **10.9 Installation of crane base of chassis and initial tower section**

#### 10.9.1 On expendable in-situ base

10.9.1.1 Most climbing cranes and other tower cranes which are capable of height extension or dismantling by methods similar to those described in sub-sections 10.16 and 10.18 below have special lugs or other attachments fitted on certain sides of their tower sections to facilitate these operations. Therefore, when installing the base and initial tower sections, it is necessary to ensure that they are correctly orientated so that the jib, which may not be allowed to slew during extension or dismantling, will be in the correct position relative to the sides of the tower and to surrounding structures. This may present no serious problem during extension because clear space is usually available and it involves only lifting additional tower sections and placing these in position at the top of the tower.

10.9.1.2 During dismantling, however, while the jib and counter jib are being lowered, they should be clear of the face of the building and all surrounding structures, which they can do only if the tower has been correctly orientated initially.

10.9.1.3 If corner angles are found to be incorrectly positioned or out of plumb, no attempt should be made to correct these by bending, nor should bolt holes be elongated.

10.9.2 On own base (without bogies or wheels)

The crane base should be assembled in the correct orientation relative to surrounding structures and construction work (see sub-section 10.9.1 above). It should be set level, adequately packed and supported on suitable material, and grouted in to ensure even distribution of load. Holding down devices should be tightened and the whole assembly checked for correct positioning and plumb.

10.9.3 Rail-mounted cranes

The rail track should be checked for correct gauge and level before the crane base is assembled. For reasons similar to those given in sub-section 10.9.1 above, the crane base should be assembled on the rails in the correct orientation. Driven bogies and/or sliding axles should be correctly positioned in relation to rail curves in accordance with the manufacturer's instructions.

10.9.4 Climbing cranes

Where the crane is used initially on an expendable in-situ base or on its own base without bogies or wheels, the precautions given in sub-sections 10.9.1 and 10.9.2 above should be observed. In all cases care should be taken at the time of installation to ensure that the tower is correctly orientated and that climbing equipment is correctly positioned and attached.

10.9.5 Truck, trailer and crawler-mounted tower cranes

These are usually erected by a self-erection procedure. The manufacturer's instructions should be strictly followed, and general precautions given in this section should be observed where applicable.

**10.10 Erection of tower**

10.10.1 When the base or chassis has been set up, the tower (which may include the slewing gear and tower head) is then erected and attached to it using a second crane or a self-erection procedure. In either case the tower should be correctly orientated within the base section.

10.10.2 Where the jib is attached to the tower head before the tower is raised from horizontal to the vertical position, some means, such as a plank or board should be placed beneath the outer end of the jib to ensure that it can move freely across the ground as the tower is raised.

10.10.3 Where a second crane is used for erection, the number of sections in any tower sub-assembly should be minimum as to eliminate excessive stresses in the assembly when it is raised from the horizontal to the vertical position. It is recommended that jib-ties are attached before the jib is raised and positioned at the top of the tower section. When a tower section or sub-assembly has been



placed in position, all bracings, locking devices, etc., should be attached and bolts securely tightened before proceeding with the next stage of the erection operation. It is essential to ensure that any specially strengthened tower sections are positioned where required.

- 10.10.4 It may be necessary to guy or support the tower depending on its free standing height. When tensioning the guys, ensure that the pull is even on each and that the tower remains perfectly plumb. Ensure also that blocking is installed in the tower to support the guys and to prevent the tower from being damaged.

### **10.11 Assembly and erection of counter jib**

- 10.11.1 The counter-jib should be correctly assembled on level ground or on levelled trestles. Where it carries a trolley to which the counterbalance weights are attached, the trolley (without weights) and its associated ropes should be attached to the counter-jib before it is erected and securely fastened so that it will not slip when the counter-jib is lifted into position.

- 10.11.2 Where a second crane is used for erection, the counter-jib should be slung in a way that facilitates the entry of its foot into the slewing section of the tower. Where a self-erection procedure is used, erection ropes should be correctly reeved and the appropriate locking devices used at all times.

- 10.11.3 Undue force should not be used when inserting foot pins which should be lubricated before insertion, and locked in position before the free ends of ties are attached. The security of all pins, bolts and other locking devices should be checked.

### **10.12 Counterbalance and ballast weights**

- 10.12.1 It is emphasized that at each stage of the erection/dismantling operation the correct amount of ballast and counterbalance should be in the appropriate position on the crane. The manufacturer's specific instructions should be followed on this point and particularly in regard to slewing the counter-jib and counterbalances before main jib is installed.

- 10.12.2 Weights for ballast or counterbalance should be made in accordance with the manufacturer's instructions. All pieces of ballast and counterbalance should have their weights clearly marked upon them. The construction of counterbalance weights should include the facility for adding small amounts in order to obtain the correct total. Where the counterbalance is made up of a number of individual weights, they should be tied together to prevent movement.

- 10.12.3 Permeable substances such as sand whose weight is affected by moisture content, should not be used as counterbalance or ballast unless their weight

can be accurately determined and they are held on a crane in a weatherproof container on which the contained weight is clearly marked.

- 10.12.4 The lifting point on ballast blocks should be inspected regularly to ensure that they have not deteriorated and are fit to use.

### **10.13 Assembly and erection of main jib**

- 10.13.1 The assembly of the main jib should be carried out in accordance with the manufacturer's instructions, preferably at ground level. Care should be taken to ensure that the jib sections are assembled in their correct order and relative positions. It is essential that at all times the jib is correctly supported as specified by the manufacturers in order to avoid overstressing during assembly and erection. Horizontal trolley jibs should be held clear of the ground on trestles or other supports in order to facilitate the attachment of the trolley. With the trolley positioned on the jib, the traversing rope should be tensioned initially with the tension adjusting devices back-off. The trolley should be temporarily secured to the jib while the jib is raised into position. The correct functioning of the pulleys and other mechanical devices on the jib should be checked, and limit switches and associated wiring installed, while the jib is on the ground.
- 10.13.2 Where a second crane is used to erect the main jib, precautions similar to those given for the counter-jib should be observed regarding slinging and the insertion and locking of jib pins, etc. Sufficient steady lines should be attached to the jib to ensure that it can be held under complete control during the whole lifting and attaching operation, and these should not be detached until all stays are secured and all pins have been locked.
- 10.13.3 Where a self-erection procedure is used, the jib should be assembled in the appropriate position and line relative to the tower. And, as stated in sub-section 10.10.2, some means should be provided to ensure that the outer end of the jib is free to move along the ground. Where the inner end of the jib is first attached to the slewing section of the tower, care should be taken to ensure that pins are in position and securely locked and that the erection rope has been correctly reeved and re-attached before the outer end of the jib is raised. The erection rope should not be released until the jib is securely held in the erected position by stays, luffing rope, or other means.
- 10.13.4 When the jib is held in position by a number of ties or holding ropes, these should be correctly paired, positioned and adjusted to the appropriate tensions.
- 10.13.5 Where the jib is luffed by means of hydraulic rams, the correct functioning of these and the associated lock valves should be carefully checked before the jib is raised.

- 10.13.6 On some cranes, the jib, counter-jib and slewing assembly are put together at ground level and then raised to the top of the tower by a self-erection procedure. When this operation is carried out by means of an erection rope as distinct from jacks, this rope may have heavy strains placed upon it and should accordingly be in good order and correctly reeved. Care should also be taken to ensure that all pulleys are free to rotate and that movement of the rope and the assembly being erected is not obstructed in any way.

#### **10.14 Attachment of load-radius indicators and jib angle indicators**

- 10.14.1 Load-radius indicator should be attached to the main jib. For machines having jibs capable of moving in the vertical plane, jib angle indicators should also be attached.
- 10.14.2 On horizontal trolley jibs where the positions for the load-radius indicators are not marked, the appropriate distance should be accurately measured from the centre of rotation of the crane.
- 10.14.3 When calibrating or checking the load-radius indicator of a luffing jib, the radii corresponding to each safe working load should be accurately measured from the centre of rotation of the crane to the centre line of the hook which should carry the appropriate load. The indicator should be set to read correctly when viewed from the operating position.

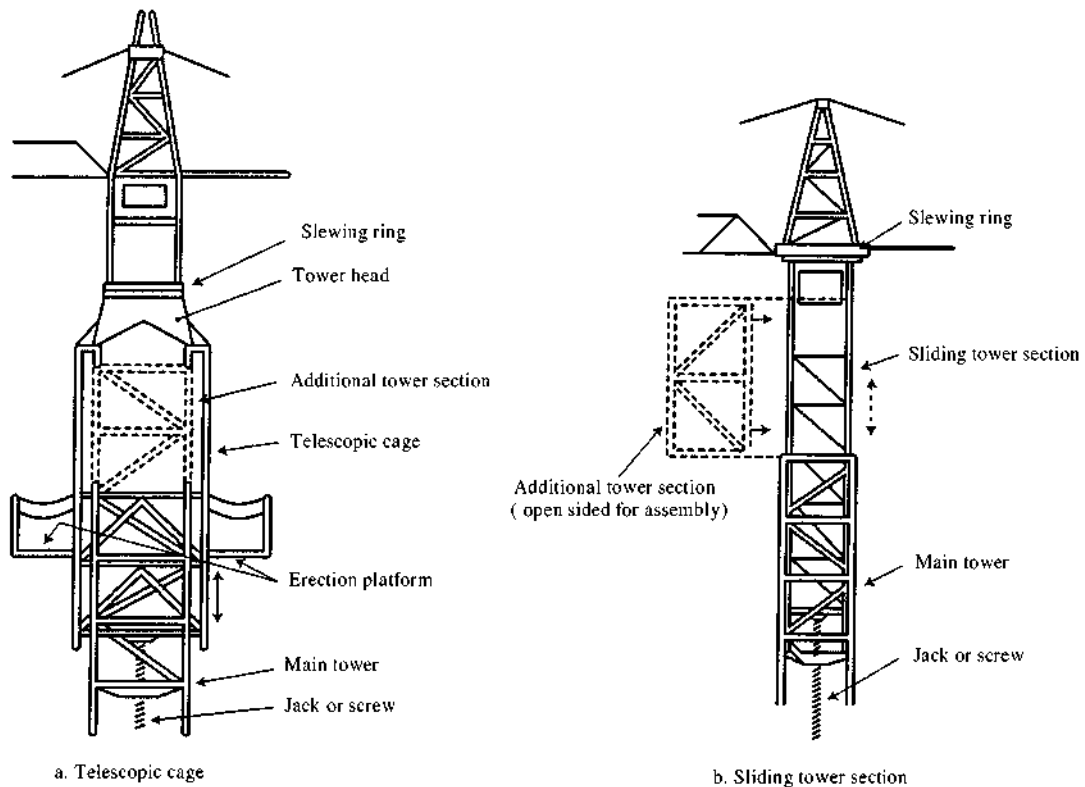
#### **10.15 Check on completion of erection**

- 10.15.1 On completion of erection, before being taken into use, the tower crane shall be tested and examined by a competent examiner in accordance with the statutory requirements set out in section 14 below. Before these tests and examinations are carried out, it is recommended that a visual inspection of the crane be made by the competent person supervising the erection, followed by functional checks.
- 10.15.2 In the visual inspection, particular care should be taken to ensure the following:
- (a) all bolts and locking devices are correctly positioned and secured;
  - (b) the load/radius indicator and automatic safe load indicator are correctly fitted;
  - (c) access ladders, safety platforms and walkways are in position and secure; and
  - (d) ropes are correctly reeved and all machinery guards have been replaced.
- 10.15.3 A functional check of the crane should then be carried out under no load conditions to ensure the correct operation of all motions, limit switches and brakes. It is recommended that these checks are then repeated with a light load on the crane.
- 10.15.4 On cranes equipped with change speed gear, these checks should first be carried out in a low gear and then repeated in fast gear with appropriate loads.

- 10.15.5 On hoist mechanisms where the gear change passes through neutral between low and high speed, when changing gear, the hook block should be lowered to the ground or other suitable precaution taken to prevent the block from falling and the hoist rope unwinding from the drum.
- 10.15.6 All hoisting ropes should comply with BS302: Stranded Steel Wire Ropes, BS EN 12385: Steel Wire Ropes-Safety or equivalent national standards.
- 10.15.7 Under no circumstances should the gear change be operated when a load is suspended from the hook. Before the crane is put into service, a further check should be made of all fastenings and anchorages.

## **10.16 Height alteration of a tower crane**

- 10.16.1 The height of some tower cranes can be altered by adding or removing sections of the tower without dismantling the jib/counter-jib/cat-head assembly or other parts of the crane structure.
- 10.16.2 One method employs a telescopic cage which encircles the top of the tower and has one 'open' side (see Fig.10). When additional tower sections are to be added, the cage is used to raise the jib/counter-jib/cat-head assembly from the top of one tower. Additional sections can then be lifted, passed through the 'open' side of the cage and attached to the top of the tower and to the tower head. Similar operation to remove sections applies to the lowering of the crane. The owner should ensure the hydraulic system associated with the telescopic cage should be properly tested in accordance with the manufacturer's recommendations before it is being used in each operation.
- 10.16.3 Another method employs a sliding tower section within the top of the main or outer tower and which carries the jib/counter-jib/cat-head assembly (see Fig.10). The height of the crane is extended by successively attaching additional sections to the top of the outer or main tower and then raising the sliding tower section within them.
- 10.16.4 In each case, the telescopic cage or sliding tower section is raised by means of lugs or other attachments on certain sides of the tower, and the self-dismantling procedure is the reverse of the erection procedure. In general, the jib/counter-jib/cat-head assembly should not be slewed during tower extension or dismantling operations; the consequent importance of the correct orientation of the tower is discussed in sub-section 10.9 above.



Note : additional working platforms at high levels of the telescopic cage should be provided whether a long telescopic cage is used.

**Fig. 10 Tower extension equipment**

- 10.16.5 Before proceeding with the height alteration, checks should be carried out to ensure that the wind speed does not exceed the limit specified for this operation, that the correct amount of ballast is in position of the crane, and that the final height will not be greater than the free standing height without ties or the appropriate height above the last tie as specified by the manufacturer (see sub-section 10.17 below).
- 10.16.6 The tower crane should be properly balanced in accordance with the manufacturer's instruction prior to and during the height alteration of the tower crane.
- 10.16.7 The jib should be correctly orientated relative to the tower, and when necessary locked in position to prevent uncontrolled slewing. Before tower locking devices are freed and the height extended, the correct attachment and functioning of tower extension equipment should be ensured, and the crane correctly balanced. Care should be taken to guard against over-extension of the telescopic cage or sliding tower, and to ensure that the whole operation is carried out in accordance with the manufacturer's instructions.
- 10.16.8 Suitable working platform(s) should be provided for totally embracing the telescopic cage used for tower extension. When a long telescopic cage is used, additional working platform(s) at high level of the telescopic cage should be provided for the erection workers.
- 10.16.9 The tower sections to be inserted should be correctly assembled on the ground,

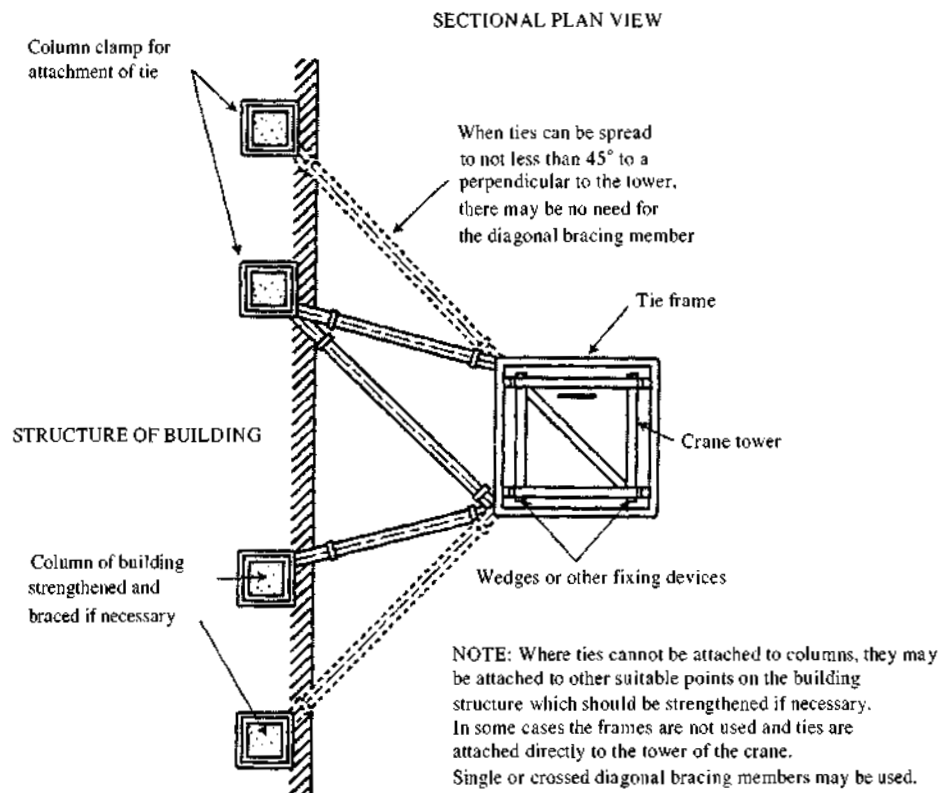


and controlled by steady lines when being lifted into position and attached. Access ladders and safety platforms should be added at appropriate positions as the height of the crane is extended.

- 10.16.10 On climbing cranes where the crane is supported and its height extension effected within a structure or building, the climbing operation should be carried out in accordance with the manufacturer's instructions. All climbing frames, ladders, locking devices and machinery should be correctly installed, adjusted, and in good working order. Shoring is erected to the underside of the floors which will support the weight of the crane. At the end of the climbing operation it is particularly important that the wedges securing the tower are driven home and secured. The tower should also be ensured to be plumb.
- 10.16.11 Upon completion of height alteration operations, all fixings and permanent locking devices should be checked, before the statutory tests referred to in section 14 below are carried out.

## 10.17 Free-standing height and tying back

- 10.17.1 Static and rail-mounted tower cranes are designed to be free-standing up to a specified height. If this height is to be exceeded, the tower of the crane should be securely anchored at the appropriate levels (see Fig. 11).



**Fig. 11 Tying back a tower crane**

- 10.17.2 Some rail-mounted tower cranes may be used as static machines up to a specified height which is greater than their free-standing (travelling) height. In such cases, the wheels should be blocked in position on the rails and the travelling controls disconnected to ensure that at the increased height, they do not travel when handling a load. No part of any rails on which a crane is mounted or the sleepers supporting such rails shall be used as anchorage for the purpose of ensuring the stability of the crane.
- 10.17.3 The free-standing height of the crane should be given at the handbook, but the manufacturer's advice should always be sought on appropriate methods of tying back the crane, and the most critical in-service and out-of-service forces that the crane will transmit to the ties, the tie frames bracing member(s) and to the structure to which it is tied. It is then the responsibility of a site safety personnel to certify, by means of an adequately designed and braced anchorage, that the structure is able to withstand the additional forces and that as the height of the crane is increased ties and tie frames are attached at the appropriate levels. For construction site, when the installation of the tower crane may have effect on the permanent structure by way of overstressing or overloading, the safety supervision personnel should submit the certified plan, design information and/or method statement to the project engineer and certify the completion of work.
- 10.17.4 Before any ties are attached, the crane should be balanced in accordance with the manufacturer's instructions to ensure that the tower is vertical and that the restraint afforded by the ties does not subsequently cause any undue stress in the tower. The manufacturer's advice should also be followed in respect of the position of tie frames relative to the tower joints, and where ties occur between tower joints, whether diaphragm bracing or other stiffening of the tower is necessary. The tower should be securely wedged within the frame, the wedge being locked in position. During attachment, the weight of the tie should be supported from the tower of the crane to prevent it deflecting at the tower end.
- 10.17.5 Regulations/procedures should be made for the inspection of all tie anchorages (see sub-section 14.1 below).
- 10.17.6 The attachment, addition, or alteration of any ties which connect a tower crane to a structure may be required so that its normal free-standing height can be exceeded. The anchorage and/or structure of the crane should then be re-tested in accordance with the statutory requirement (Regulation 5(5) of the LALGR). Before the statutory tests are carried out, a thorough visual check should be made to ensure the security of all fixings, structural joints, wedges and locking devices.

## 10.18 Dismantling

- 10.18.1 Dismantling a tower crane may be difficult and potentially dangerous operation. The relevant precautions given in this section should be observed at all times, particularly in respect of the manufacturer's instructions. It should also be ensured that the correct amount of ballast is in the appropriate position of the crane during all stages of the operation.
- 10.18.2 With many tower cranes, the dismantling procedure is the reverse of the erection procedure. However, dismantling a crane is more complicated than erecting it because of the space restrictions imposed by the structure which the crane has been used to construct and by the proximity of other buildings. It is essential therefore that the requirements for dismantling and removing the crane are considered at the outset of a project when selecting the type, size and position of the crane to be used.
- 10.18.3 Equipment used to lower dismantled assemblies should be of adequate capacity to enable these to be lowered to the ground well clear of the building or structure. The equipment including all lifting gear should be tested and thoroughly examined by a competent examiner and carries appropriate test certificates issued by the competent examiner. It is recommended that steady lines are used to steady any load that has to be lowered down from the face of the building and that these are attached before lowering commences.
- 10.18.4 Whatever procedure and means for lowering are used in dismantling the crane, sections to be dismantled and lowered should be secured to the hook or lifting attachment of the lowering equipment before any bolts or locking devices are released.
- 10.18.5 Tower cranes are particularly severe on their slewing rings and ring bolts, and cracks have been found in many instances at the welding of the gusset plates in the tower ring. Severe accident would occur due to the fatigue failure of the bolts. It is strongly recommended that the joint between the gear ring in the crane base and the tower top ring be broken whenever the crane is moved to a new workplace and the used bolts should be destroyed. The tower ring should be examined for weld cracks and for flatness of the bolting surfaces when dismantled and before each erection. Lack of bearing area at the contact face of a bolt head can lead to slackness under cyclic loading, with the consequent danger of inducing fatigue cracks.

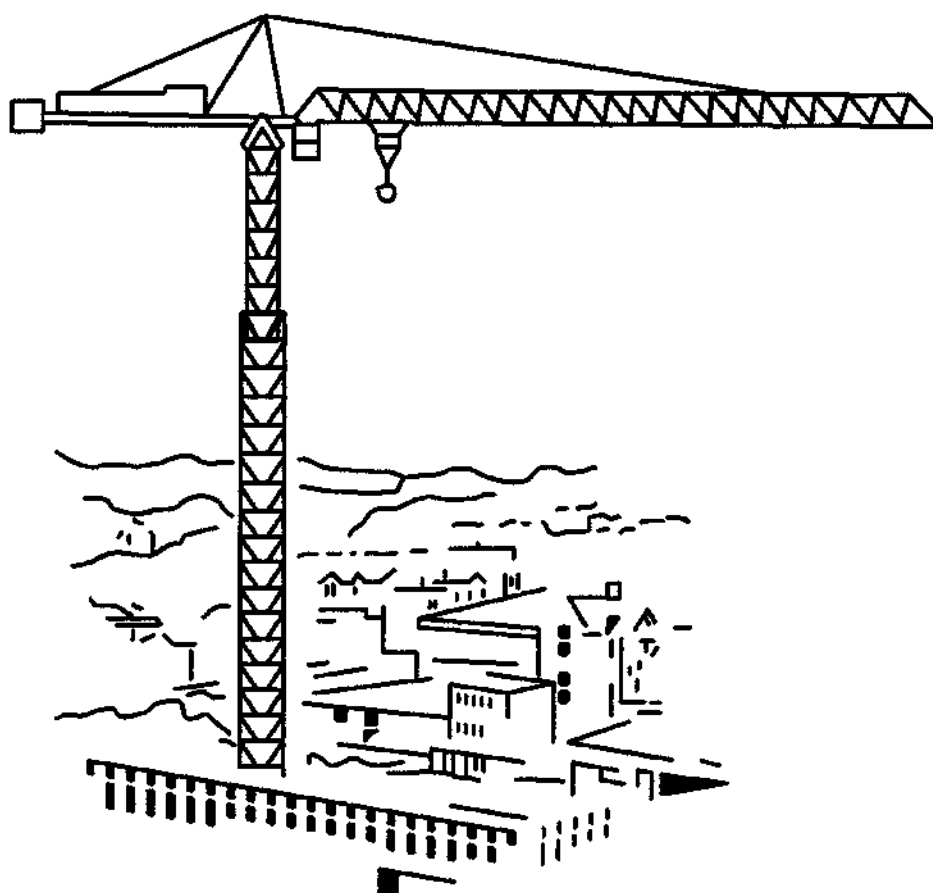
## **10.19 Use of derrick crane**

- 10.19.1 If a derrick crane is used to erect or dismantle a tower crane, the owner of the derrick crane should ensure pre-delivery checking of critical parts of the derrick crane has been carried out by a competent examiner in accordance with the procedures in Annex 3. The owner should ensure a report on pre-delivery checking has been certified by the competent examiner and submitted to the owner before the erection of the derrick crane.
- 10.19.2 The report on pre-delivery checking of derrick crane is valid for no more than 12 months.

## 11. Procedures and Precautions

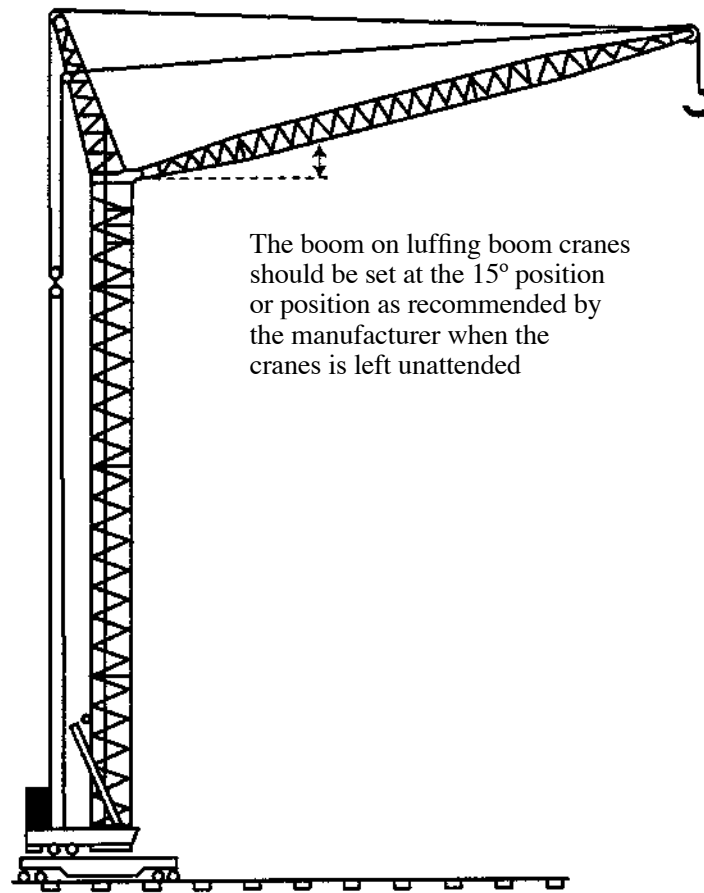
### 11.1 Leaving the crane unattended

- 11.1.1 A crane should not be left unattended, however short the period is, unless all loads have been removed from the hook and the electric power supply has been switched off, or the engine stopped, and appropriate motion brakes and locks have been applied to put the machine in a safe condition. When the crane was left unattended, the hook should be brought to the highest working position at the appropriate radius and the power of the crane should be switched off.
- 11.1.2 For details of methods to safeguard particular types of cranes, reference should be made to the crane manufacturer's instructions.
- 11.1.3 If it is left unattended for a relatively long period of time or is out-of-service, long-term isolation measure should be taken i.e., switches locked off, fuel supplies cut off and any doors giving access to machinery or control cabins locked to prevent unauthorized access. The ignition key and any other keys should be removed from the crane at any time when the operator is absent from the machine. When adverse weather conditions are expected, the appropriate out-of-service procedures should be followed which may include moving the crane to an anchorage point and attaching rail clamps and/or other means of security. The main jib should be slewed to the side of the tower away from the wind, and then put into free slew; the power supply switched off and locked; any fuel supplies cut off; and doors or panels giving access to electrical or mechanical equipment closed and locked.
- 11.1.4 The trolley of the crane with horizontal trolley jib should be placed near to the tower at minimum radius and the hook should be raised to its highest position (see Fig. 12).
- 11.1.5 Where the "in service" condition allows a tower height greater than permissible for out of service conditions, the crane should be guyed or anchored to the building.
- 11.1.6 On luffing jib cranes (including the articulated jib cranes), the jib should be brought to the 15° position or position according to manufacturer's recommendation and the hook raised to its highest position (see Fig. 13).
- 11.1.7 Where the crane has warning lights fitted to the top of the tower or to the jib, these should be switched on if it is to be left unattended over night.
- 11.1.8 Before being left for a long period, tower cranes which do not have continuous full-circle slewing should be slewed-back into their mid-position (see sub-section 12.2 below).



When leaving the crane unattended, position the trolley at minimum radius and raise the hook to its highest position.

**Fig. 12 Leaving the crane unattended**



**Fig. 13 Boom angle of luffing crane when the crane is left unattended**

## 11.2 Routine checks

- 11.2.1 At the beginning of each shift or working day, the operator, if competent for the purpose, or a competent person, should carry out the following routine checks, as appropriate:
- checks as required by the manufacturer's instructions;
  - check that the automatic safe load indicator is correctly set and/or fitted with the correct jib length (or jib and fly-jib lengths) and falls of hoist rope;
  - check that the correct load-radius scale appropriate to the jib (or fly-jib) length is fitted on the visual indicator;
  - check crane level indicator (where applicable);
  - check working space limiter/anti-collision system (where applicable);
  - check audio and visual alarming devices;
  - check the security of the counterweight or ballast where this is in the form of removable weights, check that the weights fitted correctly correspond to those shown on the counterweight chart for the operating condition [Note: Where the stability of a crane is secured by means of removable weights, a diagram or notice indicating the position and amount of the weights shall be affixed to the crane in a place where it can easily be seen (Regulation 7F of the LALGR);

- (h) check the oil level(s), fuel level and lubrication;
- (i) check hook for signs of cracks and wear;
- (j) check loosening of pins, bolts and nuts;
- (k) check the ropes, and rope terminal fittings and anchorages for obvious damage and wear;
- (l) check the condition and inflation pressure(s) of tyres (where applicable);
- (m) check that all water is drained from any air receivers;
- (n) check the jib structure for damage;
- (o) check the operating pressures in any air and/or hydraulic system(s);
- (p) check leakage of brake fluid and hydraulic oil;
- (q) check the operation of the crane through all motions with particular attention to brakes to ensure that these are operating efficiently;
- (r) check the operation of all limit switches or cut-outs (use caution in making the checks in case of non-operation);
- (s) on rail-mounted cranes the wheels and axles are in good condition; the cable drum is free to revolve and the cable does not foul on any part of the crane structure;
- (t) all rail clamps and out-of-service anchorages have been released;
- (u) the track is in good condition and clear of obstructions, and that there is no undue settlement, loose joints, cracks, or gaps between adjacent length of rail;
- (v) the crane is placed out of service when the wind speed registered is near the manufacturer's safe working limit and that where an anemometer is fitted to the crane, it is in working order;
- (w) split pins and locking cellars are in position on jib and counter-jib ties and counter balance hanger bars;
- (x) the travel warning device operates;
- (y) on a climbing crane all climbing frames and wedges are secure, and that the anchorages and wedges on any tower ties or tie frames are secure and locked in position where necessary; and
- (z) for safety and to prevent the risk of fire, the crane cabin is in a tidy state, is free from tins of grease and oil or other fluids; from rags, tools, shackles, and other materials, and that a fire extinguisher suitable for extinguishing both electrical and other types of fire is available in a convenient place in the crane cabin.

11.2.2 A full inspection of the crane shall be carried out by a competent person at least once a week. Apart from those items covered in the daily inspection, attentions should also be paid to all anchorages, fixing and structural members. The check should include identifying of significant cracks and flaking of the paint on structural members and joints, which are usually signs of permanent deformation and loose joints. Bolts should be checked for tightness and welded joints inspected for cracks. Check the slewing rings, slewing gears and gusset plates in the tower ring for cracks. This section of the crane takes the direct torsion



load of braking and acceleration of the slewing motions which constitute a high proportion of the crane's duty cycle; further, the load is a cyclically reversing head, the worst possible condition for producing fatigue failures. The competent person should also check for any abnormal noise while the crane is in motion as this is usually the sign of crane damage.

- 11.2.3 Use of "Check List" for carrying out the above mentioned routine checks is recommended. A certificate in an approved form stating that the tower crane is in safe working order shall be submitted to the owner by the competent person when no defect was found in the weekly inspection.
- 11.2.4 Should the person carrying out an inspection find any defect (such as twisted/broken wires, etc.) or abnormality in the tower crane or in the operation of the tower crane, or should the tower crane be accidentally damaged, this should be reported immediately to the person responsible for the safe use of the tower crane. The machine should be taken out of service until the faults have been rectified and clearance is given by the responsible person. Sufficient space on the "Check List" for reporting the defects are recommended.

### **11.3 Permit to work**

- 11.3.1 Before any major repairs, adjustments or inspections are carried out on a crane, a proper system of granting permission to work should be considered. Such a permit to work system properly implemented will ensure that the necessary precautions are taken to make the crane safe for maintenance or repair work, etc. (e.g. by isolation and lock-off of electrical equipment, removal of ignition keys, etc.) and will notify all affected persons that the crane may not be used.
- 11.3.2 A permit to work is a specially designed form issued only by a responsible person. It indicates that special precautions have been taken to make it safe for work on the machine to proceed for a specified period of time. The form should also specify any additional precautions which should be observed by persons carrying out the work. The responsible person should be the person in charge of the site.
- 11.3.3 Most system requires that the person performing the work should retain the permit in his possession while carrying out this work. Where several persons are involved on the same job, the permit should be held by the senior person (e.g. a foreman). A commendable practice in this respect is for the permit to be placed in a specially designed carrier (e.g. weatherproof transparent plastic jacket) and displayed in a prominent position on the crane involved, such as on the access door or at the crane operator's station, to indicate that personnel are working on the machine.

- 11.3.4 When the work is completed, all permits should be returned to and duly endorsed by the person who issued them before the crane is 'handed over' for normal use. This procedure is as important as the original certification. The responsible person in charge should ensure that all persons who worked under the permit are clear of the machine or area. He should also ensure equipment that was brought in for the work is removed, all safety guards on the crane are replaced and the machine is in all respects safe for normal use, subject to the conditions specified in section 14 below.

## **11.4 Safe means of access**

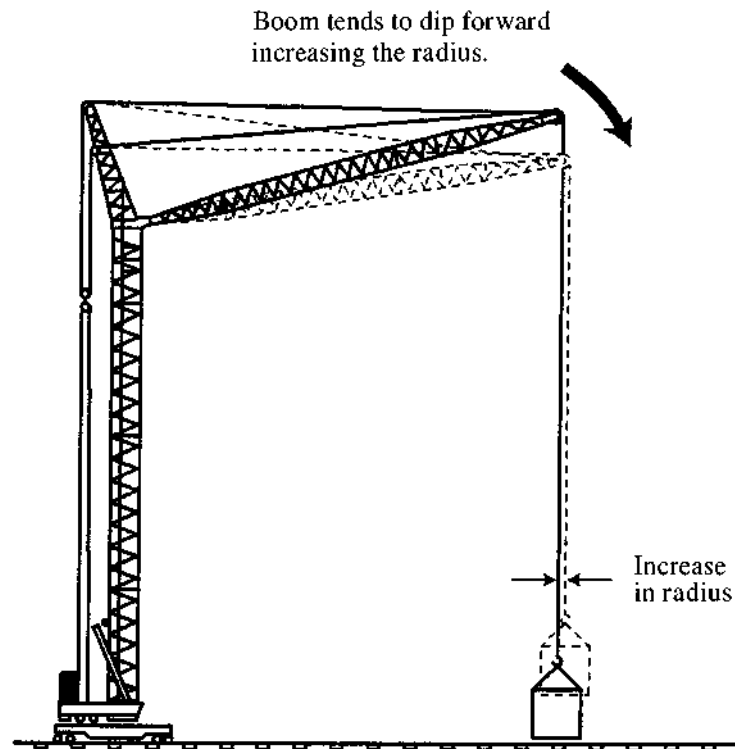
- 11.4.1 Safe means of access and egress shall be provided to a tower crane and shall be properly maintained. Suitable access ladders with safety hoops should be provided for access to the operator cabin from ground level or the lowest level of the tower mast. Suitable rest platforms should also be provided at intervals of not greater than 9 meters. Suitable access should also be provided between the building/structure and the tower mast. For the maintenance of access ladder, particular attention should be paid to the removal grease/oil and cement /concrete on the ladders. Measures should be taken to prevent persons falling through floor openings through which the tower passes when they make access or egress at the tower ladder.
- 11.4.2 It is recommended that cat-walks with handrails are provided wherever they would facilitate access for the purpose of routine maintenance or inspection. It is also recommended that safety lines with runners for the attachment of safety harnesses are fitted to horizontal trolley jibs where personnel are required to work on or move along the jib to permit full passage along the jib without detachment. An alternative means of access is by means of a safety platform or trolley with person-carrying cage attached to the trolley. The movement of the platform should be controlled by the person or persons travelling in it.
- 11.4.3 Only crane operator and authorized maintenance staff should be allowed to climb onto the crane structure in order to gain access to the cabin or to carry out such tasks as maintenance or inspection.
- 11.4.4 Because of the risks of trapping, no person should be allowed to climb the mast to the cabin, jib, counter-jib or cat-head, unless the crane operator is aware of this and has clearly indicated that it is safe to do so.

## 12. Safe Working Loads and Operating Conditions

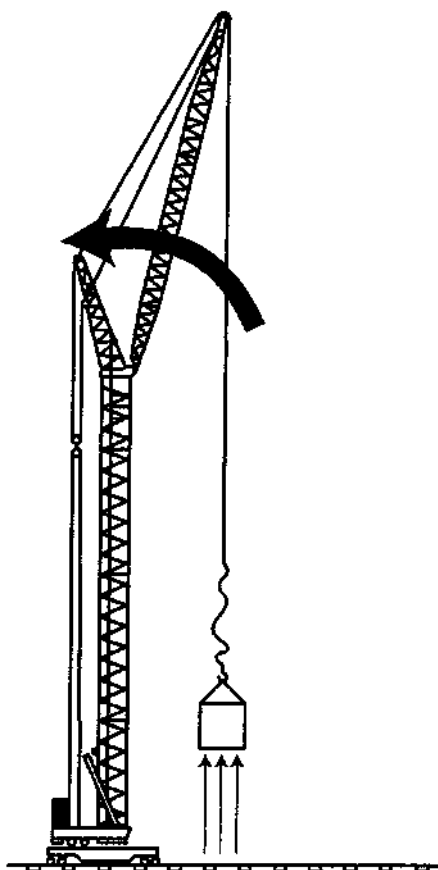
### 12.1 Safe working loads

- 12.1.1 The safe working load of a tower crane is the hook load specified for a given radius, with the appropriate rope reeving and length of jib, and with the crane standing on a firm, level base or track. In assessing the weight of the useful load, allowance should therefore be made for the weight of slings or other tackle used to attach the load to the hook. Consideration should also include the dynamic effects such as jerking and impact.
- 12.1.2 The safe working load of a crane is defined in the LALGR as the appropriate safe working load for operating the crane as specified in the current certificate of test and thorough examination delivered in the approved form by a competent examiner in respect of that crane (Regulation 3(1) of the LALGR). In other words, the safe working load is the maximum load under specified conditions for which a crane may be used.
- 12.1.3 Safe working loads are generally calculated as a percentage of the ultimate load of a crane. The ultimate load will be the tipping load for certain cranes.
- 12.1.4 But for others, a structural failure would occur before the crane reached a tipping condition, and, in these cases the ultimate load will relate to the manufacturer's design capacity of the crane.
- 12.1.5 The margin between the safe working load and the ultimate load is a safety margin to allow for the various forces which will act on the crane in operation. These include allowances for wind loading and for dynamic forces set up by normal operational movement of the crane and load.
- 12.1.6 Tower cranes and their associated lifting gear shall be clearly marked with their safe working loads. Means of identification shall be provided (Regulations 11(2) and 18 of the LALGR).
- 12.1.7 Safe working loads apply only to freely-suspended loads. Before lifting a load the hoist line should be plumb. It is expressly forbidden to use the crane hook or slewing motion of a crane to drag any load along the ground, etc. Similarly, sideward pushing/pulling the load whether with bare hands or by chain block(s) or by similar equipment should be discouraged. Failure to observe these points may endanger the stability of the crane or introduce loadings (stresses) into the jib for which it has not been designed for. Even with an automatic safe load indicator fitted, a structural failure may result without any prior warning being given.
- 12.1.8 In case a tower crane is used to drag a load not in a vertical direction, steps shall be taken to ensure that no undue stress is imposed on any part of the structure or mechanism of the crane thereby endangering the stability of the crane and such use is supervised by a competent person (Regulation 15(1) of the LALGR).

- 12.1.9 Reference should always be made to the crane manufacturer's handbook of appropriate machine specification to establish the restriction, limitations or special conditions applicable to a particular crane.
- 12.1.10 The radius increases whenever a heavy load is lifted off the ground by luffing boom or articulated jib cranes because the boom/jib suspension ropes would be stretched and the boom/jib and tower would deflect forward. This should be taken into account when assessing the radius of the load, especially for long boom/jib machines (see Fig. 14).
- 12.1.11 It is essential to avoid sudden snatching, swinging and stopping of suspended loads when using tower cranes since rapid acceleration and deceleration would greatly increase the structural stresses. The sudden movements can produce forces well in excess of the weight being handled. These forces can cause failure of the hoist rope, pendants, tower, boom/jib or some other less significant load supporting component. Excessive pulling on a load which is caught or frozen to the ground should also be prohibited since it would produce similar results if it suddenly breaks loose. In particular, this could make the boom/jib whip backwards and collapse back over the tower when operating luffing boom/articulated jib machines at high boom/jib angles (see Fig. 15).
- 12.1.12 On luffing boom/articulated jib cranes, boom/jib "kick back" should be watched for. The boom/jib should never be operated at a higher angle than shown on the capacity chart as a sudden release of the load may throw the boom/jib back over the tower (see Fig. 15).



**Fig. 14 Increasing radius**



If a load suddenly breaks free, the boom will snap back and could collapse over the tower.

**Fig. 15 Sudden release of a load**

## 12.2 Mode of operation and control

- 12.2.1 Each crane control shall be clearly identified to indicate its purpose and the mode of operation (Regulation 16(2)(b) of the LALGR). When practicable, the crane control shall also be provided with suitable spring or other locking arrangement to prevent accidental movement or displacement (Regulation 16(2)(a) of the LALGR).
- 12.2.2 Before starting any lifting operation with a crane, the operator should ensure:
- (a) that he has a clear and unrestricted view of the load and operational area; if not, he should act under the directions of an authorized signaller who is positioned to have such a clear and uninterrupted view;
  - (b) where telephone or radio communications are being used, that the calling signal is functioning and that verbal messages can be clearly heard; and
  - (c) that all gauges are reading correctly and that air or hydraulic systems are up to operating pressure.

- 12.2.3 When handling load which approaches the maximum working load for an operating radius, crane motions should be operated with extreme care. The load should initially be lifted just clear of the supporting surface and brought to rest which the slings, balance of the load, etc., are checked before proceeding further. Proper care should be exercised by the operator, at all times, to avoid shock or side loadings on the jib.
- 12.2.4 No load is allowed to be left suspended unless a competent person is in charge of the crane during the period of suspension (Regulation 12A of the LALGR) and the operator should remain in the driving position. The machine should be fully operational to meet any emergency arising and with the hoist brake lock, the boom derricking safety pawl and the swing lock/brake, where fitted, all engaged. Under no circumstances should the crane be left unattended with the load suspended.
- 12.2.5 Where a wanderlead and control box is provided for the remote operation of a tower crane, particular care should be exercised when operating the crane by this means. The control should be isolated when the wanderlead is being moved from one operating position to another. Any carrying harness attached to a control box should be fitted with a quick release device.
- 12.2.6 On cranes which do not have continuous full circle slewing, care should be taken to ensure that the stipulated number of turns in one direction is not exceeded. It is recommended that this type of crane is fitted with a slewing revolution counter with audible or visual warning signals, which can be read from the crane cabin or operating position.

### **12.3 Handling of loads near persons**

- 12.3.1 When loads have to be handled in the vicinity of persons, extreme care should be exercised and adequate clearances allowed.
- 12.3.2 Lifting of loads over highways, railways, or other places to which the public have access should be avoided.

### **12.4 Carrying of persons by crane**

- 12.4.1 A crane can only be used to carry persons where the use of a builder's lift or a suspended scaffold is impracticable. The carrying of persons by a crane is subject to certain statutory regulations. Requirements include provision of a properly designed safety chair, skip or cradle. Suitable measures are to be taken to prevent such chair, skip or cradle from spinning or tipping in a manner dangerous to any occupant. It is recommended that personnel should not be lowered other than by an engine-power-controlled load-lowering mechanism. The occupant of the chair, skip or cradle should wear a safety belt secured to a suitable anchorage (Regulation 18B of the LALGR).

## **12.5 Communication system**

- 12.5.1 In the interests of safety, a standard signalling code (see Table 1) may be adopted. It is recommended that copies of the signal code shown in Table 1 be issued to all crane operators, slingers and any other persons concerned.
- 12.5.2 In certain situations and where special lifts are involved, it may be necessary to supplement the hand signals by other forms of communication such as radio, walkie-talkie or telephone.
- 12.5.3 If tele-communication equipment such as radio or walkie-talkie is used in a multi-crane situation, suitable arrangement should be made to ensure that the radio frequency is not interrupted for whatever reason at any time during the crane operation period and correct message is received by persons using such equipment.

## **12.6 Weather conditions**

- 12.6.1 Cranes shall not be used under weather conditions likely to endanger its stability. Before a crane is taken into use after exposure to weather conditions likely to have affected the stability of the crane, the crane's anchorage or ballast shall be tested by a competent examiner (Regulation 7G of the LALGR).
- 12.6.2 Any instructions issued by the crane manufacturers advising conditions under which a crane should be taken out of service and recommending the conditions in which it should be placed should be strictly followed. During adverse weather conditions such as rainstorm and lightning, adequate precautions should be taken to prevent personnel associated with the use of the crane from being endangered.
- 12.6.3 Cranes are generally designed to operate in conditions of normal steady wind speed and should not be operated in wind speeds that are in excess of those specified in the operating instructions for the crane. Gusty wind conditions may have an adverse effect on safe working loads and machine stability. Even in relatively light wind conditions it is prudent to avoid handling loads presenting large wind-catching surfaces.
- 12.6.4 Where a load has a large surface area in relation to its weight, for example a large timber shutter or panel, the action of the wind or the load may give rise to unsafe working conditions in respect of the strength or stability of the crane, or because the load cannot be adequately secured against swinging or spinning; with some loads this can occur at wind speeds below that specified for in-service conditions. Under such circumstances the size of the hook load should be limited to that which can be safely handled by the crane and which will not create unsafe conditions for operatives.

- 12.6.5 Name boards or other items presenting a wind catching area should not be fitted to the jib, counter-jib, or tower of a tower crane without the express approval of the manufacturer.
- 12.6.6 An anemometer or wind speed measuring device should be provided at a suitably elevated position on all tower cranes. Where practicable the indicator of the instrument should be fitted at the crane operator's station. Necessary actions on the operation of tower cranes which correspond to various magnitudes of measured wind speed as recommended by the manufacturers should be strictly adhered to.
- 12.6.7 If the visibility or range of sight of the operator is impaired by adverse weather conditions, strict supervision of the crane operation should be exercised. Where appropriate crane operations should be temporarily suspended.

## **12.7 Special conditions**

- 12.7.1 In all case where a tower crane is to be used for the purpose or in a manner outside normal duties, the manufacturer's advice should be obtained. Tower cranes should not be used for grabbing, magnet or demolition ball service, tandem lifting, piling operations or any other duties which might impose excessive and/or indeterminate loadings onto the crane structure.
- 12.7.2 In all situations where the crane operator does not have an unrestricted view of the load and is acting upon the instructions of a slinger or authorized signaller, the responsibility for the lifting operation should be clearly designated, and understood by all those involved. Exceptionally difficult lifting operations should be rehearsed with a dummy load on the hook.
- 12.7.3 Every tower crane should be on a firm, level base or track with its tower vertical when handling loads. The manufacturer's advice should be sought before the crane is used under other conditions.
- 12.7.4 Where a crane can be fitted with hoist drum shells of different diameters, the manufacturer's advice should be obtained on the diameter to be used in relation to the height of the crane, the number of falls on the hook, and the specific duties involved. Also, where a crane is to be above its free-standing height the manufacturer's advice should be sought on the possible need for de-rating to make allowance for the weight of the rope and the number of falls on the hook.
- 12.7.5 Where a crawler or truck-mounted or wheel-mounted tower crane is designed to be partially or completely supported on outriggers and jacks when handling loads, these should be extended and set in accordance with the manufacturer's instructions. On machines with pneumatic tyres it is important to ensure that the tyres are in good condition and inflated to the recommended pressures.



## 13. Maintenance

### 13.1 Statutory requirements

- 13.1.1 Cranes should be properly maintained (Regulation 4(b) of the LALGR). Table 2 gives the legal requirements under the LALGR for the testing and examination of cranes after substantial repair.

### 13.2 Planned maintenance

- 13.2.1 In order that a tower crane may operate safely and efficiently, it is essential to carry out preventive maintenance work so that the risk of accidents and stoppages owing to breakdowns are reduced to a minimum. Further to the weekly full inspection of the crane by a competent person (see sub-section 11.2.2 above), the owner shall ensure every tower crane erected is inspected and maintained at least once a month by inspection and maintenance technician(s) holding the “Training Certificate of Routine Inspection and Maintenance of Tower Cranes” issued by the Construction Industry Council Training Academy. If the manufacturer’s instruction manuals recommend that specific tasks be carried out at stated intervals, such procedures should be followed. Any repairs or replacement components should be in accordance with the manufacturer's recommendations or specifications. To avoid excessive down-time, expendable items such as ropes, friction linings, etc., should be kept in stock.

- 13.2.2 The owner should ensure the inspection and maintenance results are properly kept for record under an inspection and maintenance form prepared by the inspection and maintenance technicians. The inspection and maintenance works should be performed are detailed in Annex 4. The owner should be informed immediately if any parts of the tower crane require instant repairing.

- 13.2.3 In addition to any statutory regulations, a record or log should be kept for all cranes, giving information such as diameter, length and construction details of ropes, hours worked, adjustments, insulation checks, renewal of parts, thorough examinations and repairs. Based on this record a programme of planned maintenance and repair work should be introduced to contribute towards trouble free and safe operation.

### 13.3 Competency of maintenance personnel

- 13.3.1 All maintenance staff should be fully aware of the hazards involved in working on cranes. Maintenance staff should have an adequate working knowledge of the machinery they are required to maintain and have access to the manufacturer's relevant literature.

- 13.3.2 The maintenance foreman should be responsible for instructing the staff in all aspects of safe working, including the use of tackles. Where special machinery is involved, personnel should be properly instructed, such as by attending maintenance, service and operating courses given by the manufacturer of the equipment.

#### **13.4 On-site repair/replacement work of an erected tower crane**

- 13.4.1 When on-site repair or replacement work of major component(s) of an erected tower crane is required, the owner should ensure that a competent person carries out risk assessment and prepares safe method statement for the work. The safe method statement should also include safe methods and procedures for the lifting and rigging work involved.
- 13.4.2 If any on-site repair or replacement work may affect the stability of a tower crane or its components, the owner should ensure measures are taken to stabilize and secure every affected component of the tower crane before the work is to commence.
- 13.4.3 The owner should ensure that all on-site repair or replacement work are carried out and supervised by competent persons.

## 14. Inspection, Examination and Testing

- 14.1 There are statutory requirements governing the testing, examination and inspection of tower cranes (Regulations 5, 7A, 7B, 7E and 7G of the LALGR). Weekly inspection shall be carried out by a competent person whilst test and examination shall be carried out by a competent examiner. Reference can be made to Table 2 which is a summary of the legal requirements of testing, thorough examination and inspections of tower cranes. Testing of tower cranes should conform to British Standard 7121 or equivalent standards. Reference should also be made to the Guidance Notes on Inspection, Thorough Examination and Testing of Lifting Appliances and Lifting Gear issued by the Labour Department.
- 14.2 Pre-delivery checking of every tower crane should be carried out by the competent examiner as described in sub-section 10.7 above before the tower crane is delivered to a workplace for erection.
- 14.3 It should be noted that when a tower crane is climbed within a building or structure by means of its climbing frames and ladders, or when its height is altered by adding or removing sections to the tower, or when there is an alteration in the ties which connect it to a structure so that its normal free-standing height can be exceeded, this constitutes an alteration to the anchorage and/or the structure of the crane which shall therefore be re-tested in accordance with statutory requirements (Regulation 5(5) of the LALGR).
- 14.4 A competent examiner or competent person who has carried out any test, inspection or examination shall deliver forthwith, or within a reasonable time thereafter, to an owner a report or certificate of such test, inspection or examination (Regulations 21(1) and 22(1) of the LALGR).
- 14.5 Where a test or a thorough examination shows that a crane is in a safe working order, the competent examiner shall deliver the test or examination certificate to the owner of the crane within 28 days after the test or the thorough examination (Regulation 6A(1)(a) of the LALGR).
- 14.6 Where a test or a thorough examination shows that a crane cannot be used safely unless certain repairs are carried out, the competent examiner shall immediately inform the owner of the crane of that fact and shall, within 14 days after the test or the thorough examination, deliver a report to the owner of the crane and a copy of it to the Commissioner for Labour (Regulation 6A(1)(b) of the LALGR).
- 14.7 A competent examiner or competent person shall not deliver to an owner a certificate or make a report which is to his knowledge false as to a material particular (Regulation 21(2) and 22(2) of the LALGR).
- 14.8 All test certificates or copies of certificates and related documents shall be kept in the cranes or be available on the site of operation (Regulation 18C of the LALGR).

## 15. Securing of Loads before Lifting

### 15.1 Loads to be safely secured

15.1.1 The owner of a lifting appliance shall, before it is used, ensure that every part of any load to be raised or lowered by the lifting appliance is -

- (a) securely suspended or supported; and
- (b) adequately secured so as to prevent danger arising to persons or property as a result of the slipping or displacement of any part of the load.

(Regulation 7J(1) of the LALGR)

15.1.2 The risk of the slipping or displacement of any part of the load as well as the falling down of the load as a whole should be properly considered during the establishment of the safe system of work (see section 3 above).

15.1.3 Particular attention should be paid to the provisions of proper rigging procedures and precautions. It should also be noted that it is the responsibility of owner to ensure that the men who direct, rig and handle the loads have received training in the principles of the operation, are able to establish weights and judge distances, heights and clearances, are capable of selecting tackle and lifting gear as well as rigging method suitable for the loads to be lifted, and are capable of directing the movement of the crane and load to ensure the safety of all personnel.

15.1.4 It should also be noted that loose materials, such as stones, bricks, tiles, slates or other objects have to be lifted in a receptacle of adequate strength. Where a receptacle is used for raising or lowering stones, bricks, tiles, slates or other objects, the owner of the lifting appliance or lifting gear shall cause the receptacle to be enclosed or to be so constructed or designed as to prevent the accidental fall of any such objects (Regulation 7J(3) of the LALGR).

### 15.2 Precautions to be taken before the lifting operation

15.2.1 The weights of loads to be handled should be determined or properly assessed.

15.2.2 Proper rigging methods should be established.

15.2.3 Suitable lifting gear, equipment and tackle should be employed.

15.2.4 Functional check to the mechanism in respect of changing 2 falls to 4 falls lifting operation should be conducted.

15.2.5 Particular consideration should be given to the balance of the loads to be lifted. As far as reasonably practicable, designed lifting points should be provided. If lifting points are not provided, the position of the centre of gravity should be

assessed. It is important that the supporting hook should be positioned directly above the centre of gravity. The type of sling and the slinging methods used should ensure that the load would not topple or slip.

- 15.2.6 Every lifting gear, equipment or tackle to be used should comply with the statutory requirements concerning the construction, safe working loads, marking of safe working loads, testing, examination, inspection, etc. laid down in Part III of the LALGR.
- 15.2.7 Where a wire rope sling is employed, the sling should not be allowed to damage the load, nor should the sling itself be damaged. If the sling is to be attached to the load, the points used for attachment, e.g. lugs and eyebolts, should be suitable and adequate for the purpose of lifting the whole load.
- 15.2.8 Suitable packing should be provided and used to prevent damage to slings by sharp edges on loads.
- 15.2.9 When lifting rigid objects with slings having three or four legs, any two of the slings must be sized in capable of supporting the total load. In other words, after considering the angle between the legs, the slings should be considered as having only two legs when sizing the sling requirement. Where the object is flexible and able to bend to adjust itself to the sling legs, each leg can be assumed to take its own share of load.
- 15.2.10 When using multi-legged slings to lift loads in which one end is much heavier than the other, the decision to select the appropriate sling should be based on the most heavily loaded leg rather than the total weight.
- 15.2.11 As far as reasonably practicable, the effective diameter of any pin, hook or other component over which soft eyes are used should not be less than twice the rope diameter for single part legs, and four times the rope diameter for double part legs.
- 15.2.12 It is important to note that the weights of loads, the rigging methods adopted as well as the safe working loads of the lifting gear, equipment and tackle should be made known to the rigging crew.

### **15.3 Methods of slinging, their application and limitations**

- 15.3.1 There are many rigging methods for different kinds of loads being handled. It should be noted that a rigging method which is suitable for handling one load might not be suitable for handling another load. In fact, each rigging method

has its limitations. The methods shown in this section are intended to be typical examples and should not be regarded as exhaustive.

15.3.2 It should be noted that though wire rope slings are used for illustration, the methods shown in this section are also applicable to the use of suitable chain sling.

15.3.3 The owner of any double or multiple sling shall ensure that it is not used in raising or lowering or as a means of suspension if -

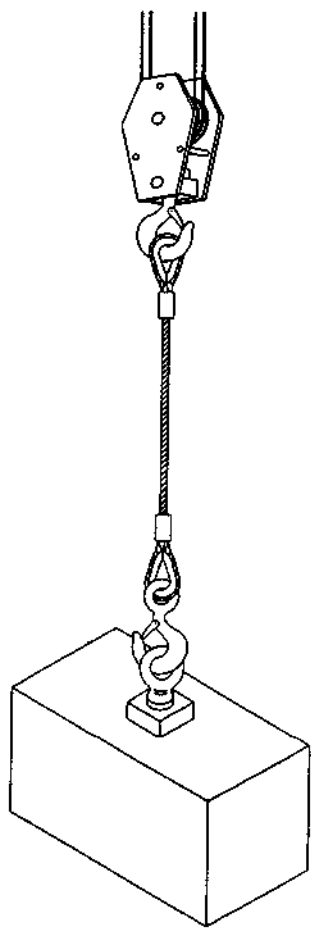
- (a) the upper ends of the sling legs are not connected by means of a shackle, ring or link of adequate strength; or
- (b) the safe working load of any sling leg is exceeded as a result of the angle between the sling legs.

(Regulation 18A of the LALGR)

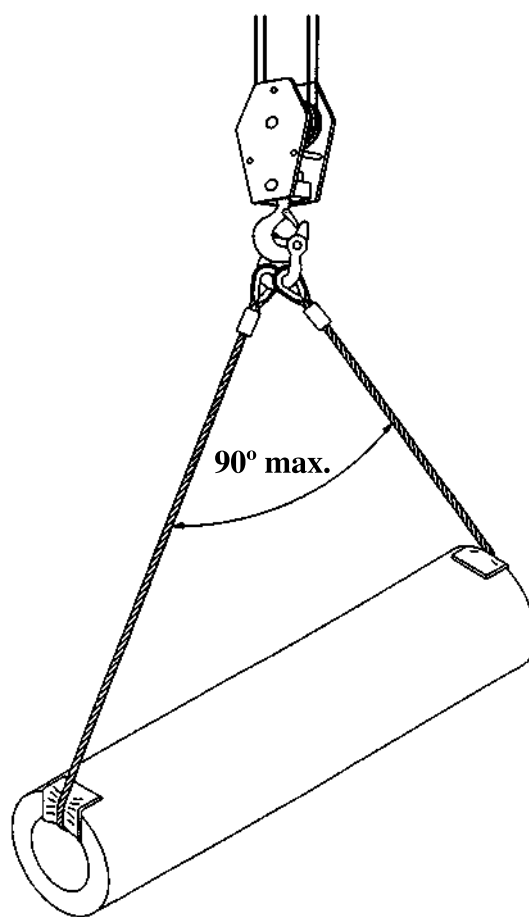
15.3.4 Single-leg sling

- (a) *Vertical or straight lift* (Fig. 16) – A vertical or straight lift is only suitable for lifting a load that will be stable when suspended from a single lifting point.
- (b) *Basket hitch* (Fig. 17) – A basket hitch should only be used when the sling is passed through part of the load and the load is balanced on the sling. The lifting should not commence until a shackle is connected to the sling legs. The included angle of the sling should not exceed 90 degrees.
- (c) *Simple Choker Hitch* (Fig. 18) and *Double and Choked* (Fig. 19) – These two slinging methods do not grip the loads completely and should be used only when the loads are easily stabilized or cannot slip out of the sling.
- (d) *Choker hitch double wrapped* (Fig. 20) – The general limitations for this sling method is similar with simple choker hitch, except that with the double wrapped choker hitch the load is gripped more fully, and hence is secured more effectively.

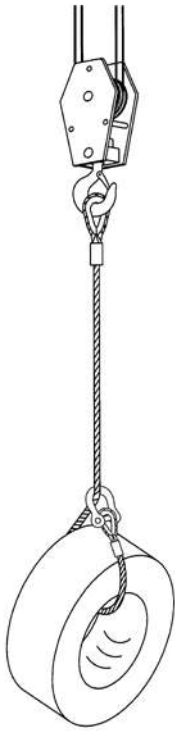
Note : The simple choker hitch or choker hitch double wrapped method should not be used for handling composite loads such as loose bundles of tubes, or bars or wooden battens unless the friction grips between the parts is sufficient to prevent them slipping from the sling. As far as possible, such composite loads should first be tied up securely at their ends by steel wires or similar means of adequate strength.



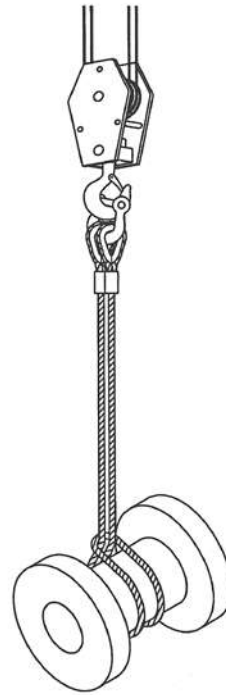
**Fig. 16: Vertical or straight lift**



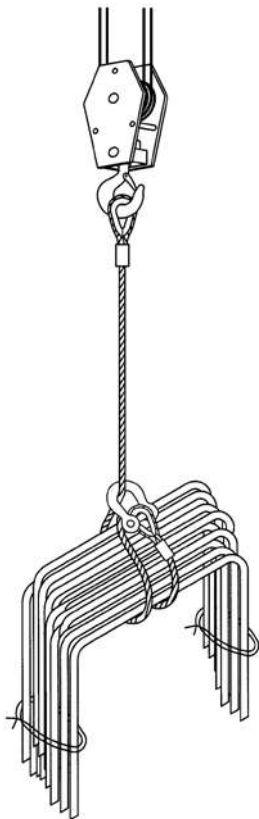
**Fig. 17: Basket hitch**



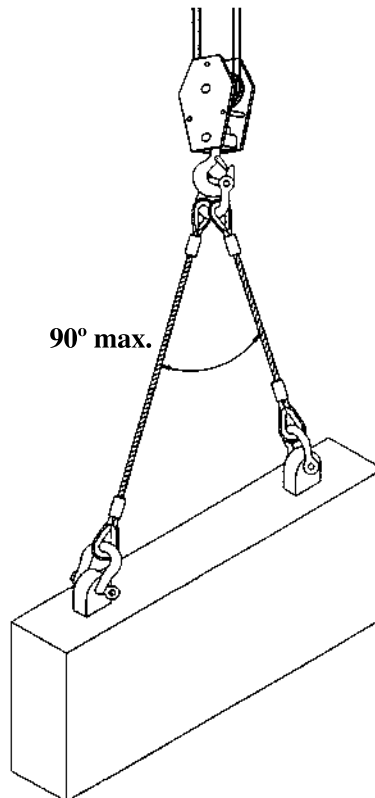
**Fig. 18: Simple Choker Hitch**



**Fig. 19: Doubled and choked**



**Fig. 20: Choker hitch double wrapped**



**Fig. 21: Two single-leg slings used with direct attachment**

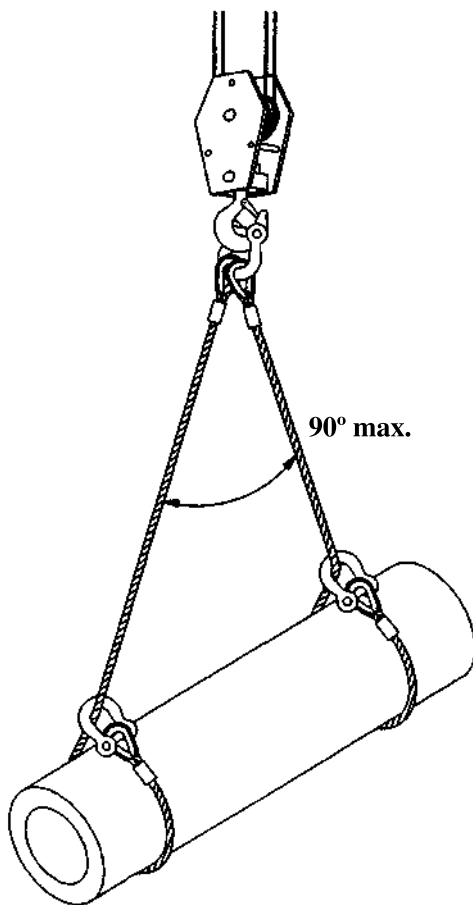


### 15.3.5 Multi-leg sling

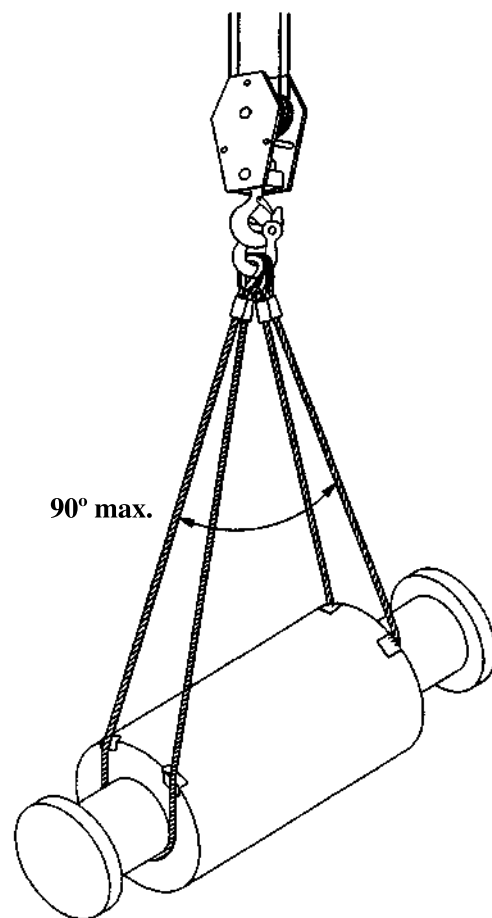
15.3.5.1 A multi-leg sling may have two, three or four legs (Fig. 21 to 27). It provides a more stable lifting arrangement than a single-leg sling.

15.3.5.2 Generally, multi-leg sling methods are :

- (a) two-leg slings used with direct attachment (Fig. 21);
- (b) two-leg slings used in choker hitch (Fig. 22);
- (c) two-leg slings used in basket hitch (Fig. 23);
- (d) two-leg slings used in double wrap choker hitch (Fig. 24);
- (e) two-leg slings used in double wrap basket hitch (Fig. 25);
- (f) three-leg slings used in direct attachment (Fig. 26); and
- (g) four-leg slings used with direct attachment (Fig. 27).



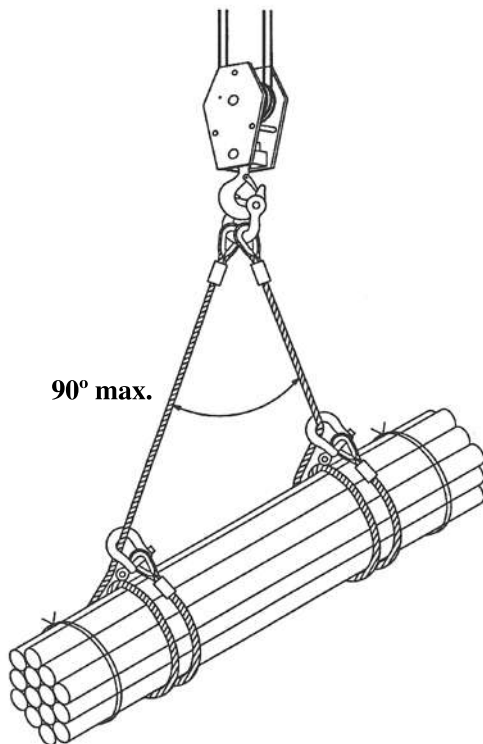
**Fig. 22: Two single-leg slings used in choker hitch**



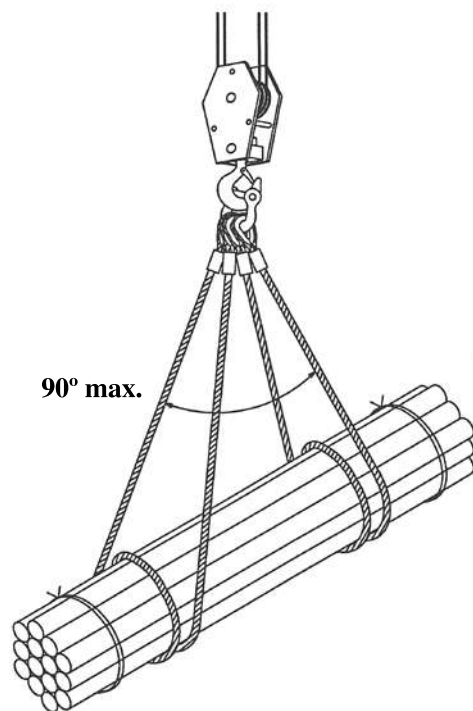
**Fig. 23: Two single-leg slings used in basket hitch**

- 15.3.5.3 When using multi-leg slings, care should be taken to ensure that:
- the slings are of the same length;
  - where the slings have different safe working load ratings then the load that can be lifted is related to the least safe working load; and
  - the attachment points of a two-leg sling to the load are far enough apart to give stability without exceeding 90 degrees (Fig. 21, 22 & 24). In the case of two-leg sling used in basket hitch or a four-leg sling, the angle between any two diagonally opposite legs should not exceed 90 degrees (Fig. 23, 25 & 27) unless the sling is so marked. In no circumstances should the included angle exceed 120 degrees. For a three-leg sling, any one leg should make an angle of not greater than 45 degrees with the vertical.

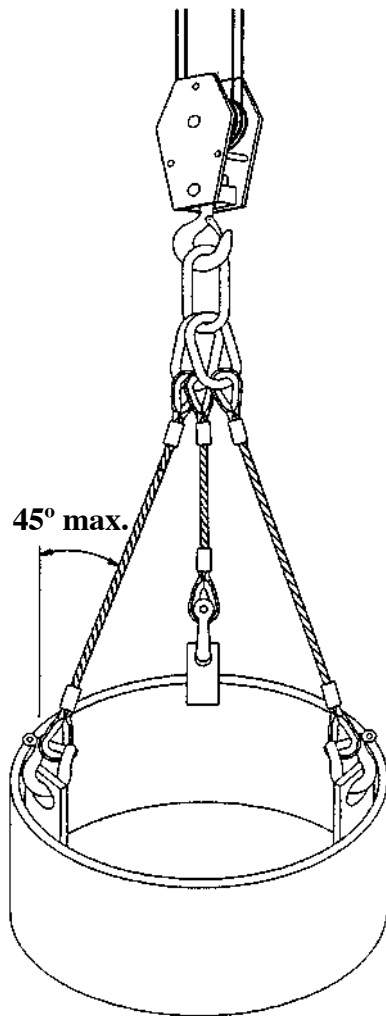
Note : The two-leg slings used in choker hitch, basket hitch, double wrap choker hitch and double wrap basket hitch should not be used for handling composite loads such as loose bundles or tubes, bars or wooden battens unless the friction grips between the parts is sufficient to prevent them slipping from sling. As far as possible, such composite loads should first be tied up securely at their ends by steel wires or similar means of adequate strength.



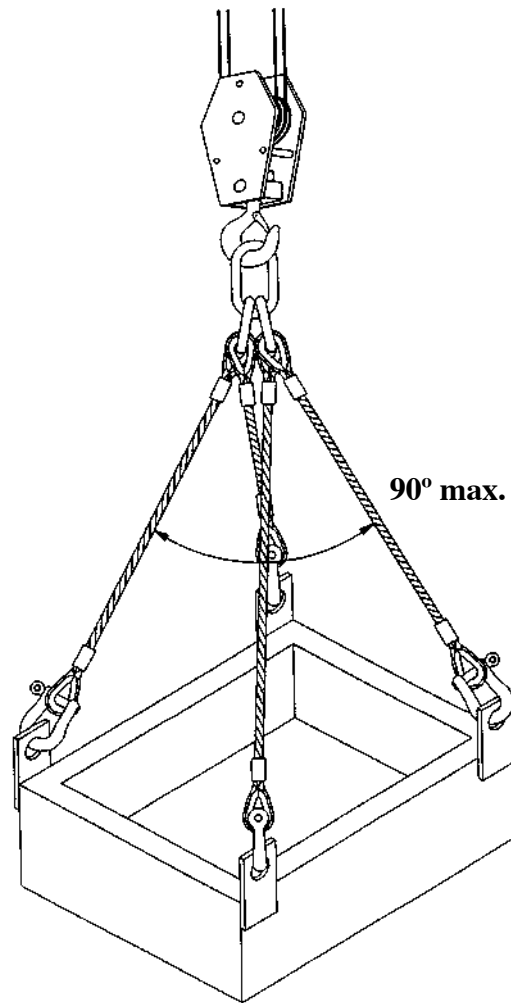
**Fig. 24: Two single-leg slings in double wrap choker hitch**



**Fig. 25: Two single-leg slings in double wrap basket hitch**



**Fig. 26: Three-leg sling**



**Fig. 27: Four-leg sling**


## 15.4 Precautions to be taken in fitting the slings

15.4.1 When fitting the sling to a load, steps should be taken to ensure that:

- (a) sling legs are free of any tendency to kink;
- (b) only the eye termination or link is placed on the crane hook;
- (c) the terminations are properly seated without overcrowding;
- (d) the load is effectively secured by the sling;
- (e) the relevant leg angle does not exceed that for which the sling is rated and marked;
- (f) the sling is not bent around any corners that might damage or reduce the effective strength of the sling. Where necessary suitable packing pieces should be used;

- (g) when using choke hitch:
  - (i) the angle of choke is allowed to form itself naturally and is not forced;
  - (ii) a thimble or stirrup is used where practicable at the eye to reduce damage to the rope and thereby prolong the life of both the eye and the main part of the rope;
- (h) a sling is not used to turn, rotate or drag a load unless special precautions are taken to ensure that neither the sling nor the load will be damaged; and
- (i) a tag line or control rope is available for assisting in the control of the swing or rotation of the load.

**Table 1 - Recommended hand signals**

 1. EMERGENCY STOP	 2. STOP	 3. TRAVEL	 4. TRAVEL TO ME	 5. TRAVEL FROM ME
 6. INDICATING DISTANCE TO TRAVEL	 7. TURN TO DIRECTION INDICATED	 8. TURN TO DIRECTION INDICATED	 9. SWING IN DIRECTION INDICATED	 10. SWING IN DIRECTION INDICATED
 11. RAISE BOOM	 12. RAISE BOOM SLOWLY	 13. LOWER BOOM	 14. LOWER BOOM SLOWLY	 15. RAISE THE BOOM AND LOWER THE LOAD
 16. LOWER THE BOOM AND RAISE THE LOAD	 17. EXTEND BOOM	 18. RETRACT BOOM	 19. USE MAIN HOIST	 20. USE AUXILLARY HOIST
 21. LOWER HOIST	 22. LOWER HOIST SLOWLY	 23. RAISE HOIST	 24. RAISE HOIST SLOWLY	 25. STOP EVERYTHING

**Table 2 - Frequency of test, thorough examination and inspection of tower cranes under the LALGR**

Regulation No.	Testing & Thorough Examination	Testing	Thorough Examination	Inspection	Approved Form No.
5(3) 7B	during the preceding 4 years before use (includes the test of the automatic safe load indicator)				3
5(5) 7B	before use, after undergoing substantial repair, re-erection, failure, overturning or collapse (includes the test of the automatic safe load indicator)				3
5(1)			at least once in the preceding 12 months		5
7A 7B				within the preceding 7 days (includes the inspection of the automatic safe load indicator)	1
7E		after erection, removal to a new location, or adjustment of any component member ( being a removal or adjustment which involves changes in the arrangements for anchoring or ballasting)	all the devices used for the anchoring or ballasting of the crane before the crane is erected		2
7G		after exposure to weather conditions likely to have affected the stability of the crane			2

Note 1: The requirements for testing/examination of lifting gear are not included in the above table.

Note 2: Reference should be made to the full text of the LALGR.

Note 3: Repair includes renewal, alteration or addition and examples of substantial repair include replacement of wire rope, replacement of brake, alteration of boom length or jib length, changing of hook block, and any repairs on steel structure which may affect the integrity of the crane.

## Annex 1 - Risk Assessment for Erection, Dismantling and Height Alteration Operations of Tower Crane

1. The owner should ensure risk assessment for erection, dismantling and height alteration operations is conducted by a safety professional such as a registered safety officer and registered professional engineers with suitable qualification and experience in appropriate disciplines should be consulted on issues resulted to structural and mechanical stability. The assessment should be updated immediately before the start of the erection, dismantling or height alteration works to take into account any changes in circumstances. Version of the risk assessment report in Chinese should be made available for reference. Suitable arrangement should be made to enhance communication in workplace where people would use languages other than Chinese.
2. The risk assessment on erection, dismantling and height alteration should include but not limited to the following:

(a) Risk assessment

Risk assessment should be conducted by taking into account all relevant matters including but not limited to:

(i) preparation work

- deployment of crew for work supervision;
- checks on the suspension points of various accessories;
- checks on the lifting appliances and lifting gear;
- operating frequencies of walkie-talkies;
- checks on hand tools and all arresting stripes;
- checks on full body harness;
- location of the exclusion zone;
- checks on personal protective equipment;
- storage of material;
- safety training;
- wind speed monitoring and the maximum allowable wind speed; and
- arrangement of the control ropes;

(ii) work commencement procedures specifying the potential risk and mitigation measure of all procedures;

(iii) work completion procedures including tests, examination and certification; and

(iv) contingency plan for emergencies.

(b) Method statement

A method statement should be drawn up in consultation with the competent person for erection, dismantling and height alteration operations of tower crane, the registered safety officer and other persons concerned; and should clearly define the procedures for every step of the operations. It should be issued to the working crew for effective compliance with the prescribed procedures.

The method statement should include:

- (i) details of the workplace and tower crane operation related works including a layout plan of area affected;
- (ii) general safety measures for the works;
- (iii) pre-construction plan, if applicable;
- (iv) operating procedures with key points illustrated by diagrammatic illustrations;
- (v) specific safety training required;
- (vi) personal protective equipment; and
- (vii) safety measures for the operation.

(c) Personal particulars of crew members

The personal particulars of staff responsible for drawing up the method statement and members of the working crew including competent person, senior workmen and junior workmen should be listed on the assessment report. The personal particulars should include:

- (i) name of the person;
- (ii) position held;
- (iii) qualifications held (including training received and certificates issued in accordance with statutory provisions); and
- (iv) year of experience.

(d) Manufacturer's manual

The owner should ensure a copy of the relevant parts of the manufacturer's manual is enclosed in the risk assessment report.



## Annex 2 - Procedures for Pre-delivery Checking of Tower Crane

1. The owner of a tower crane should ensure pre-delivery checking of a tower crane has been carried out by a competent examiner before it is delivered onto a workplace.
2. The owner should ensure the following reports on pre-delivery checking have been certified by the competent examiner and issued for checking by the owner before erection of a tower crane:
  - (a) report on pre-delivery verification of components; and
  - (b) report on pre-delivery checking.
3. The reports on pre-delivery checking are valid for no more than 12 months after certification by the competent examiner.
4. The owner should provide the following information to the competent examiner to carry out pre-delivery checking:
  - (a) origins of parts and components – written confirmation that all the parts and components are identical and equivalent to the tower crane manufacturer’s original equipment parts and components;
  - (b) unique identification of parts and components – unique identification to all main structural parts, motors, gearboxes, and braking systems of tower cranes to be used when referring to components in reports for inspection and testing, and certifications for repairs and modifications. Unique identification will be required for pins and bolts used for connecting main structural parts if systems are in place for separating those that have passed non-destructive tests from the others. However, if the crane manufacturer specifies any limitations on the usage of the pins and bolts (such as with useful life based on the number of uses etc.), unique identifiers should be provided;
  - (c) verification checklist – listing the main components making up the tower crane to help in verifying that those main components conform to the manufacturer’s specifications;
  - (d) relevant sections from the user manual – to demonstrate conformance of parts and components with the manufacturer’s specifications;
  - (e) maintenance logbook – details of the most recent repair and maintenance work performed on the critical parts as listed below:
    - (i) main structural parts;
    - (ii) motors;
    - (iii) gearboxes;
    - (iv) braking system;
    - (v) slewing ring mounting bolts; and
    - (vi) other information requested by the competent examiner; and
  - (f) in the absence of any previous maintenance logbook for imported tower cranes, certificates of fitness for use from previous owners and thorough checkings for the tower cranes by competent examiner should be obtained.

5. The competent examiner should certify in the report on pre-delivery verification of components that major components and critical parts of the tower crane conformed to the manufacturer's specifications. Full details of the particulars of the crane and the manufacturer's specifications should be indicated in the report. The main components and critical parts, where applicable, should include but not limited to the following:
  - (a) fixing angles or anchors;
  - (b) tower base undercarriage or chassis;
  - (c) tower mast sections;
  - (d) slewing ring assembly;
  - (e) tower top or A-frame;
  - (f) counter-jib;
  - (g) jib;
  - (h) ballast blocks;
  - (i) pulleys;
  - (j) wire drums;
  - (k) wire ropes;
  - (l) hook block;
  - (m) trolley;
  - (n) collars;
  - (o) telescopic cage; and
  - (p) the hydraulic system for height alteration operation.
6. The competent examiner should conduct pre-delivery checking of the main components and critical parts of a tower crane to ensure they are suitable for site installation and free of irregularity before the tower crane is delivered to the workplace by making appropriate reference to the information provided by the owner. Pin and hole diameters for pinned connections should be measured for out-of-tolerance against the manufacturer's recommendations. A checklist summarising details of the checking should be prepared by the competent examiner. The competent examiner should incorporate the results of the checking into the report on pre-delivery checking.
7. Any replaced or repaired critical parts after the pre-delivery checking should be further re-inspected by the competent examiner when they become available.
8. The competent examiner should include in the report on pre-delivery checking a review of the repair and maintenance record prepared by the tower crane owner including details of work performed on critical parts including but not limited to the following:
  - (a) main structural parts;
  - (b) motors
  - (c) gearboxes;

- (d) braking systems; and
  - (e) slewing gear mounting bolts.
9. Non-original hardware (e.g. wires, clips, bolts and nuts) can only be used if the operation manual of tower cranes stipulates any specific standard of hardware such as British Standards and the standard is specified on the hardware; or any technical laboratory can prove that the non-original hardware reaches the standard as specified in the operational manual. On the contrary, where there is no indication of standards and specifications of hardware in the operation manual, no production or imitation on the hardware is allowed. The aforesaid only refers to hardware of tower cranes, excluding any structural parts.

#### 10. Non-destructive Tests

- (a) Non-destructive tests on critical components and parts including bolts and pins and welded connections should be conducted by competent person. All bolts and pins used for connecting main structural parts should be tested. Items with cracks should be replaced.
- (b) When new pins, bolts and nuts produced by original manufacturers for first-time use are provided with original manufacturer's certification, the competent examiner could determine whether non-destructive test is required for such parts; however, the competent examiner is still required to prepare the report on pre-delivery checking. Non-destructive test such as visual check and dye check is recommended for used structural parts such as nuts. For bolts connecting panels of mast section, no non-destructive test is required on such bolts.
- (c) The competent examiner should prescribe the non-destructive tests to be conducted on welded connection based on the result of visual inspection of critical parts. The competent examiner should decide on the need to conduct non-destructive tests to new cranes or to used cranes. For critical parts over 15 years old or of unconfirmed age, the minimum amount of welded connections to be tested should be 10%. A higher percentage may be specified by the competent examiner where deemed necessary (e.g. due to a history of cracking).
- (d) If cracks are detected on any component, then all remaining welded connections on that component should be tested. Components with cracks should be replaced or repaired in accordance with the manufacturer's specifications, and should be inspected by the competent examiner.
- (e) All non-destructive test reports should be forwarded to the competent examiner for review and the review result should be included in the report on pre-delivery checking.

### Annex 3 - Procedures for Pre-delivery Checking of Derrick Crane

1. If a derrick crane is used to erect or dismantle a tower crane, the owner of the derrick crane should ensure pre-delivery checking of critical parts of the derrick crane has been carried out by a competent examiner. The owner should ensure a report on pre-delivery checking has been certified by the competent examiner and submitted to the owner before the erection of the derrick crane.
2. The report on pre-delivery checking of derrick crane is valid for no more than 12 months.
3. Procedures for pre-delivery checking of critical parts of derrick crane
  - (a) Documents to be provided by the derrick crane owner

Prior to the pre-delivery checking of critical parts by a competent examiner, the owner of a derrick crane shall provide the following information to the competent examiner for review:

- (i) Identification  
unique identification to all main structural parts, motors, gearboxes and braking systems of derrick cranes. The unique identification should be used when referring to components in reports for inspection and testing, and certifications for repairs and modifications;
  - (ii) Configuration details  
details of the main components (critical parts) making up the derrick crane to show its configuration. Details should include main dimensions of the main boom and the kingpost; and
  - (iii) Maintenance logbook  
details of the most recent repair and maintenance work performed on the critical parts listed below. Details dating further back shall be provided if requested by the competent examiner:
    - main structural parts;
    - motors;
    - gearboxes; and
    - braking systems.
- (b) Pre-delivery checking of critical parts by competent examiner

After reviewing the configuration details and the maintenance logbook, the competent examiner should carry out pre-delivery checking on critical parts of the derrick crane to ensure they are suitable for installation. The pre-delivery checking should include but not limited to the following:

- (i) main structural parts including base frame, boom, kingpost and back stay; and
- (ii) critical components including hoisting winch, luffing winch, winches for lateral swing, hoisting hook block and pulley blocks

- (c) Record of repair and maintenance work on the critical parts including any updates on the outstanding repair and maintenance work performed should be checked by the competent examiner. The review results should be included in the report on pre-delivery checking. The record should include but not limited to the following parts and components:
- (i) main structural parts;
  - (ii) motors;
  - (iii) gearboxes; and
  - (iv) braking systems.
- (d) Non-destructive tests on derrick crane by competent person
- (i) Bolts and pins  
The critical load bearing bolts and pins used for connection of main structural parts shall be subject to non-destructive tests by competent person at least once during the proceeding 12 months. Items with cracks detected must be replaced, and then further inspected by a competent examiner.  
The competent examiner should confirm the locations of the critical load bearing bolts and pins. The non-destructive test reports should be presented to the competent examiner for review.
  - (ii) Welded connections  
The welded connections for the critical load bearing structural parts should be subject to non-destructive tests by competent person at least once during the preceding 12 months. Items with cracks detected must be repaired or replaced, and then further inspected by a competent examiner.  
The competent examiner shall confirm the locations of the critical load bearing structural parts. The non-destructive test reports shall be presented to the competent examiner for review.
  - (iii) All destructive test reports should be reviewed by the competent examiner. The review results should be incorporated into the report on pre-delivery checking of derrick crane.
4. The owner should, before the derrick crane is erected, appoint a safety supervision personnel to design and certify the supporting structure of the derrick crane. In particular, where a derrick crane is supported on the roof, the adequacy of the roof for supporting the derrick crane should be assessed and certified by the safety supervision personnel. For construction site, where the installation of the derrick crane may have effect on the permanent structure by way of overstressing or overloading, the safety supervision personnel should submit the certified plan, design information and/or method statement of the works to the project engineer and certify the completion of work.
5. The anchorage of the derrick crane should be certified by a competent examiner before the crane is erected.

## Annex 4 - Monthly Inspection and Maintenance of Tower Crane

1. Further to weekly full inspection by competent person, inspection and maintenance to tower crane(s) should be carried out at least once in a month by the inspection and maintenance technicians for tower crane.
2. The inspection and maintenance technicians should properly record all their work performed and the respective findings.
3. The record should be read and signed by inspection and maintenance technician(s).
4. Inspection and maintenance record should include the following, if applicable:
  - (a) basic information such as crane model, the date of the inspection, workplace reference, workplace address, crane owner, wind speed, running hour of the crane and voltage of the power supply to the crane should be logged;
  - (b) details of inspection, maintenance and repair work carried out should be logged in the record with details of the condition of the parts inspected and whether lubrication was applied. If repair work is required or has been carried out, the details should be entered into the record;
  - (c) the inspection, maintenance and repair work carried out on critical mechanism of the tower crane, including but not limited to, if applicable:
    - I) hoisting operation of the tower crane such as:
      - i) inspection and adjustment (if required) of the braking system for hoisting, auxiliary hydraulic braking system, hook height limit switch, moment cutout switch and overload cutout switch;
      - ii) inspection of electrical parts for hoisting system, gearbox oil level and refill, hoist winch and main axle, lubrication and oiling;
      - iii) fixing of the base for hoisting parts, connection pins/bolts for gearbox and footings;
      - iv) inspection of the connections for all pulleys, hooks and pins;
      - v) inspection of the lubrication, wear and tear condition of wire ropes;
      - vi) inspection of the swivel/anti-twist device for wire ropes at jib; and
      - vii) inspection of safety latches of all hooks;
    - II) luffing operation of the tower crane such as:
      - i) inspection and adjustment of hydraulic braking system, luffing travel limit switch and trolley limit cutout switch;
      - ii) inspection of electrical parts for luffing;
      - iii) fixing of luffing parts, pins bolt and nuts;
      - iv) inspection of the lubrication, wear and tear condition of trolley pulleys;
      - v) inspection of the lubrication, wear and tear condition of wire ropes; and
      - vi) boom stops.
    - III) slewing parts such as:
      - i) inspection and adjustment to slewing limit switches;

- ii) inspection of electrical parts for slewing;
  - iii) inspection and securing of V-Belt to the slewing motor;
  - iv) inspection of the slewing gearbox oil level and refill;
  - v) inspection and fixing of the bolts of slewing bearing;
  - vi) lubrication of the slewing bearing with grease;
  - vii) lubrication of the slewing ring with grease; and
  - viii) fixing of connection pins/bolts for gearbox;
- IV) steel structure and main structural parts such as:
- i) inspection of tower base and mast base;
  - ii) inspection of the connections of all mast sections, checking for any missing split pins / bolts and nuts;
  - iii) inspection of the connections and split pins at jib and other steel structural parts / bolts and nuts;
  - iv) inspection of the welding parts of all structural components such as mast sections, slewing ring, tie bar and foundation anchor etc.;
  - v) inspection for any deformation at tower mast sections, jib and counter-jib (vertical parts and tie bars);
  - vi) inspection of the connections of climbing collars (or wall ties);
  - vii) inspection of pins and bolts of ballast blocks; and
  - viii) inspection of climbing ladders of tower crane; and
- V) condition of the hook block; and
- (d) Availability of the “Daily Inspection Records”, “Repair Logbook” and “Inspection and Maintenance Logbook” for checking should be shown in the inspection and maintenance record.

## Abbreviations

- 1) FIUO – Factories and Industrial Undertakings Ordinance (Cap. 59)
- 2) FIUR – Factories and Industrial Undertakings Regulations (Cap. 59A)
- 3) LALGR – Factories and Industrial Undertakings (Lifting Appliances and Lifting Gear) Regulations (Cap. 59J)
- 4) GOMR – Factories and Industrial Undertakings (Guarding and Operation of Machinery) Regulations (Cap. 59Q)
- 5) CSSR – Construction Sites (Safety) Regulations (Cap. 59I)
- 6) BO – Buildings Ordinance (Cap. 123)
- 7) EWR – Electricity (Wiring) Regulations (Cap 406E)
- 8) CWRO – Construction Workers Registration Ordinance (Cap. 583)



## References

1. BS CP 3010: British Code of Practice for safe use of cranes - Mobile cranes, tower cranes and derrick cranes
2. BS EN 13414-2: Steel wire rope slings – Safety – Part 2: Specification for information for use and maintenance to be provided by the manufacturer
3. BS 7121: Code of Practice for safe use of cranes – Part 1: General
4. BS 7121: Code of Practice for safe use of cranes – Part 2: Inspection, testing and examination
5. BS 7121: Code of Practice for safe use of cranes – Part 5: Tower cranes
6. BS 7262: British Code of Practice for - Automatic safe load indicators
7. BS EN 12077: Crane safety - Requirements for health and safety - Part 2: Limiting and indicating devices
8. BS EN 14439: Cranes – Safety – Tower Cranes
9. BS EN 13557: Controls and control stations
10. BS EN 13135-1: Cranes – Safety – Design – Requirements for equipment – Part 1: Electrotechnical equipment
11. BS EN 14985: Cranes – Slewing jib cranes
12. BS EN 60204-32: Safety of Machinery – Electrical Equipment of machines – Part 32: Requirements for hoisting machines
13. ANSI/ASME B30.3: Tower Cranes
14. Crane hazards and their prevention - David V. MacCollum, ASSE, USA
15. Cranes and derricks - Howard I. Shapiro, Jay P. Shapiro, Lawrence K. Shapiro, McGraw Hill, Inc., USA
16. Rigging manual - Construction Safety Association of Ontario, Canada
17. Mobile crane manual - Donald E. Dickie, Construction Safety Association of Ontario, Canada

18. Crane handbook - Donald E. Dickie, Construction Safety Association of Ontario, Canada
19. A Safety Handbook for Slings and Crane Operators, RoSPA, UK
20. Guidelines on Safety of Tower Cranes issued by the Construction Industry Council
21. Code of Practice for Site Supervision issued by the Buildings Department
22. Code of Practice for the Electricity (Wiring) Regulations issued by the Electrical and Mechanical Services Department
23. Code of Practice on Working near Electricity Supply Lines issued by the Electrical and Mechanical Services Department

## Enquiry

If you wish to enquire about this Code of Practice or require advice on occupational safety and health, please contact the Occupational Safety and Health Branch of the Labour Department through:

Telephone : 2559 2297 (auto-recording after office hours)

Fax : 2915 1410

E-mail : [enquiry@labour.gov.hk](mailto:enquiry@labour.gov.hk)

Information on the services offered by the Labour Department and on major labour legislation can also be found by visiting our Home Page on the internet. Address of our Home Page is <http://www.labour.gov.hk>.

## Complaints

If you have any complaints about unsafe workplaces and practices, please call the Labour Department's occupational safety and health complaint hotline at 2542 2172. All complaints will be treated in the strictest confidence.



**Occupational Safety and Health Branch  
Labour Department**

Published by the Occupational Safety and Health Branch, Labour Department  
Printed by the Government Logistics Department

[www.astaco.ir](http://www.astaco.ir)